

# SEBOX<sup>®</sup>

“Üretimde Kalite, Kalıpta Uzmanlık”

**2026/1 ₺**

FIYAT LİSTESİ - PRICE LIST

Mobilya Aksesuarları  
**FURNITURE ACCESSORIES**

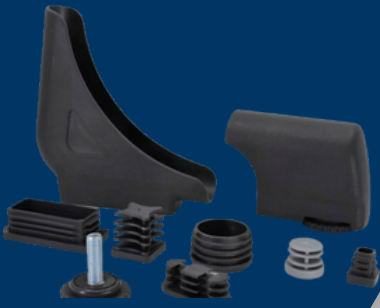

Kablo Kanalları  
**CABLE TRUNKING**

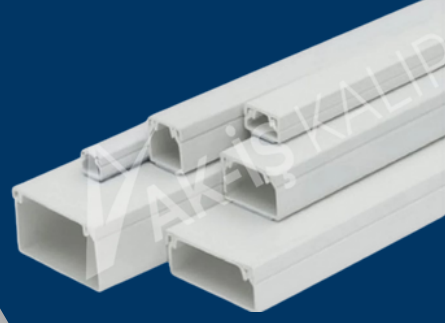

Panolar  
**BOARDS**



Buatlar  
**THERMOPLASTIC BOX**

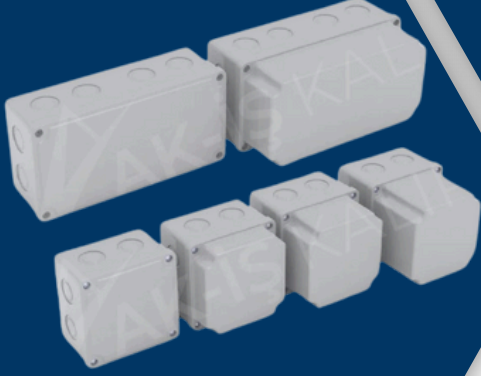

Spiral Borular  
**SPIRALS PIPES**



“Üretimde Kalite, Kalıpta Uzmanlık”

Perde Ray Aksesuarları  
**CURTAIN RAIL ACCESSORIES**



Aspiratörler  
**ASPIRATORS**

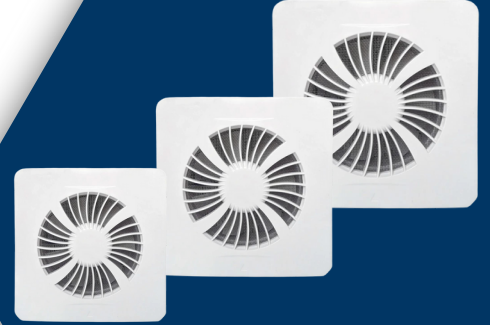

Elektronik Cihaz Kutular  
**ELEKTRONIC DEVICE BOXES**

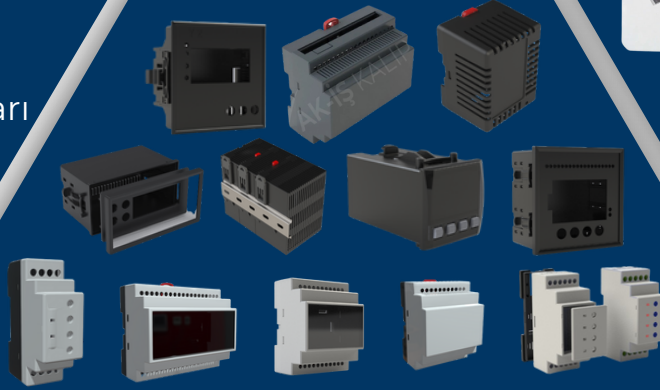

Kablo Bağları  
**CABLE TIES**



Proje Cepleri  
**Proje CepleriS**

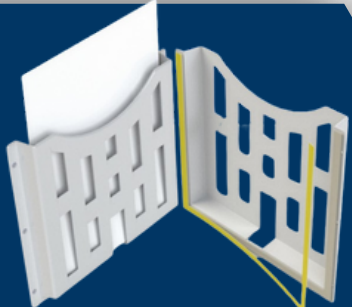

# HAKKIMIZDA

Firmamız 1992 yılından bu yana birçok sektörde plastik ürün tedarikçisi ve çözüm ortağı olmuştur. Kalite, fiyat avantajı ve teslimat sürelerine verdiği önemle kendini kanıtlamıştır. Ak-İş Kalıp, önümüzdeki dönemde hem mevcut ürün ve sistemlerdeki hem de farklı sektörlerdeki sorunları çözmek için kendini ve Ar-Ge tasarım faaliyetlerini geliştirmeye devam edecektir.



## Kalite Politikamız

Ürün ve hizmetlerimizle müşteri memnuniyetini sağlamak. Yurt içi ve yurt dışı pazarlardaki müşterilerimizin ihtiyaçlarını karşılayan ve aşan ürünler geliştirmek. Uluslararası kabul görmüş standartlara uygun hammadde ve yardımcı malzemeler kullanmak. Eğitimli, sorumluluk sahibi, sürekli kendini geliştiren ve güler yüzlü personel yetiştirmek. Temiz ve güvenli koşullarda üretim yapmak. Sürekli değişen teknolojiyi yakından takip etmek ve üretim tekniklerini güncel tutmak. Üretim süreçlerini ve kalite yönetim sistemini sürekli iyileştirmek. Maksimum kalite dengesini sağlayarak hızlı, güvenilir ve minimum maliyetli üretim yapmak.

# NELER YAPIYORUZ?



## Kalıp Tasarımı

Son derece donanımlı AK-İŞ KALIP Kalıphane Bölümü'nde plastik enjeksiyon kalıpları, progresif kalıplar, kesme kalıpları ve formlar üretilmektedir. Kalıp imalatı yapılmaktadır.

## Tasarım & Arge

AK-İŞ Kalıp, bünyesinde çeşitli bilgisayar programlarını (CATIA, MASTERCAM, SOLIDWORKS, AUTO DESK MOLDFLOW) kullanarak kalıp ve parça tasarımları yapmaktadır.

## Plastik Enjeksiyon

Üretim bölümümüzde, ileri teknoloji ile donatılmış, tonajları 120 - 1080 arasında değişen toplam 18 adet plastik enjeksiyon makinesi bulunmaktadır.

## Markalarımız

AK-İŞ KALIP oluşturmuş olduğu SEBOX ve MOBAX markalarıyla ve yatırımlarıyla müşterilerini takip etmekte en iyi hizmeti vermektedir.

# İÇİNDEKİLER

|                                      |       |
|--------------------------------------|-------|
| Opak Kapak Panolar .....             | 1-2   |
| Şeffaf Kapak Panolar .....           | 3-4   |
| Opak Kapaklı Modüler Panolar .....   | 5-7   |
| Şeffaf Kapaklı Modüler Panolar ..... | 8-10  |
| Tamamlayıcı Ürünler .....            | 11-12 |
| Termoplastik Buatlar .....           | 13-14 |
| Kablo Kanalları .....                | 15-22 |
| Kablo Kanal Aksesuarları .....       | 23-24 |
| Sigorta Kutuları .....               | 25-26 |
| Kauçuk Prizler .....                 | 27-30 |
| Kablo Makaraları .....               | 31-32 |
| Spiral Borular .....                 | 33-35 |
| Aspiratörler .....                   | 36    |
| Klemensler .....                     | 37-38 |
| Kablo Kelepçeleri .....              | 39    |
| Menholler .....                      | 40    |
| Rakorlar .....                       | 41-44 |
| Proje Cepleri .....                  | 45    |
| Grup Prizler .....                   | 46-47 |

# ABS PANOLOLAR

## Dimensions

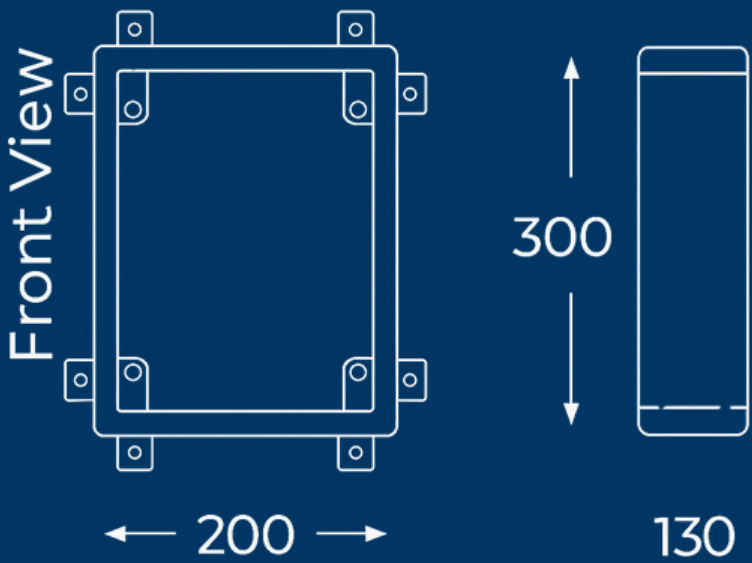

AKIŞ KALİP

|    | <table border="1"> <thead> <tr> <th>Ürün Kodu</th> <th>Kapak Tipi</th> <th>En mm</th> <th>Boy mm</th> <th>Derinlik mm</th> <th>Fiyat</th> </tr> </thead> <tbody> <tr> <td>A130</td> <td>Opak</td> <td>200</td> <td>300</td> <td>130</td> <td></td> </tr> </tbody> </table>  | Ürün Kodu | Kapak Tipi | En mm       | Boy mm | Derinlik mm | Fiyat | A130 | Opak | 200 | 300 | 130 |  |       |      |     |     |     |  |
|---|---|-----------|------------|-------------|--------|-------------|-------|------|------|-----|-----|-----|--|-------|------|-----|-----|-----|--|
| Ürün Kodu   | Kapak Tipi  | En mm     | Boy mm     | Derinlik mm | Fiyat  |             |       |      |      |     |     |     |  |       |      |     |     |     |  |
| A130  | Opak  | 200       | 300        | 130         |        |             |       |      |      |     |     |     |  |       |      |     |     |     |  |
|    | <table border="1"> <thead> <tr> <th>Ürün Kodu</th> <th>Kapak Tipi</th> <th>En mm</th> <th>Boy mm</th> <th>Derinlik mm</th> <th>Fiyat</th> </tr> </thead> <tbody> <tr> <td>A150</td> <td>Opak</td> <td>250</td> <td>350</td> <td>150</td> <td></td> </tr> <tr> <td>EA150</td> <td>Opak</td> <td>250</td> <td>350</td> <td>150</td> <td></td> </tr> </tbody> </table> | Ürün Kodu | Kapak Tipi | En mm       | Boy mm | Derinlik mm | Fiyat | A150 | Opak | 250 | 350 | 150 |  | EA150 | Opak | 250 | 350 | 150 |  |
| Ürün Kodu   | Kapak Tipi  | En mm     | Boy mm     | Derinlik mm | Fiyat  |             |       |      |      |     |     |     |  |       |      |     |     |     |  |
| A150  | Opak  | 250       | 350        | 150         |        |             |       |      |      |     |     |     |  |       |      |     |     |     |  |
| EA150   | Opak  | 250       | 350        | 150         |        |             |       |      |      |     |     |     |  |       |      |     |     |     |  |
|   | <table border="1"> <thead> <tr> <th>Ürün Kodu</th> <th>Kapak Tipi</th> <th>En mm</th> <th>Boy mm</th> <th>Derinlik mm</th> <th>Fiyat</th> </tr> </thead> <tbody> <tr> <td>A210</td> <td>Opak</td> <td>250</td> <td>350</td> <td>210</td> <td></td> </tr> </tbody> </table>  | Ürün Kodu | Kapak Tipi | En mm       | Boy mm | Derinlik mm | Fiyat | A210 | Opak | 250 | 350 | 210 |  |       |      |     |     |     |  |
| Ürün Kodu   | Kapak Tipi  | En mm     | Boy mm     | Derinlik mm | Fiyat  |             |       |      |      |     |     |     |  |       |      |     |     |     |  |
| A210  | Opak  | 250       | 350        | 210         |        |             |       |      |      |     |     |     |  |       |      |     |     |     |  |
|    | <table border="1"> <thead> <tr> <th>Ürün Kodu</th> <th>Kapak Tipi</th> <th>En mm</th> <th>Boy mm</th> <th>Derinlik mm</th> <th>Fiyat</th> </tr> </thead> <tbody> <tr> <td>A170</td> <td>Opak</td> <td>300</td> <td>400</td> <td>170</td> <td></td> </tr> </tbody> </table>  | Ürün Kodu | Kapak Tipi | En mm       | Boy mm | Derinlik mm | Fiyat | A170 | Opak | 300 | 400 | 170 |  |       |      |     |     |     |  |
| Ürün Kodu   | Kapak Tipi  | En mm     | Boy mm     | Derinlik mm | Fiyat  |             |       |      |      |     |     |     |  |       |      |     |     |     |  |
| A170  | Opak  | 300       | 400        | 170         |        |             |       |      |      |     |     |     |  |       |      |     |     |     |  |
|    | <table border="1"> <thead> <tr> <th>Ürün Kodu</th> <th>Kapak Tipi</th> <th>En mm</th> <th>Boy mm</th> <th>Derinlik mm</th> <th>Fiyat</th> </tr> </thead> <tbody> <tr> <td>A220</td> <td>Opak</td> <td>300</td> <td>400</td> <td>220</td> <td></td> </tr> </tbody> </table>  | Ürün Kodu | Kapak Tipi | En mm       | Boy mm | Derinlik mm | Fiyat | A220 | Opak | 300 | 400 | 220 |  |       |      |     |     |     |  |
| Ürün Kodu   | Kapak Tipi  | En mm     | Boy mm     | Derinlik mm | Fiyat  |             |       |      |      |     |     |     |  |       |      |     |     |     |  |
| A220  | Opak  | 300       | 400        | 220         |        |             |       |      |      |     |     |     |  |       |      |     |     |     |  |
|    | <table border="1"> <thead> <tr> <th>Ürün Kodu</th> <th>Kapak Tipi</th> <th>En mm</th> <th>Boy mm</th> <th>Derinlik mm</th> <th>Fiyat</th> </tr> </thead> <tbody> <tr> <td>A190</td> <td>Opak</td> <td>350</td> <td>500</td> <td>190</td> <td></td> </tr> </tbody> </table>  | Ürün Kodu | Kapak Tipi | En mm       | Boy mm | Derinlik mm | Fiyat | A190 | Opak | 350 | 500 | 190 |  |       |      |     |     |     |  |
| Ürün Kodu   | Kapak Tipi  | En mm     | Boy mm     | Derinlik mm | Fiyat  |             |       |      |      |     |     |     |  |       |      |     |     |     |  |
| A190  | Opak  | 350       | 500        | 190         |        |             |       |      |      |     |     |     |  |       |      |     |     |     |  |

|    | <table><thead><tr><th>Ürün Kodu</th><th>Kapak Tipi</th><th>En mm</th><th>Boy mm</th><th>Derinlik mm</th><th>Fiyat</th></tr></thead><tbody><tr><td>A180</td><td>Opak</td><td>400</td><td>500</td><td>180</td><td></td></tr></tbody></table>          | Ürün Kodu | Kapak Tipi | En mm       | Boy mm    | Derinlik mm | Fiyat | A180 | Opak | 400 | 500 | 180 |           |
|---|---|-----------|------------|-------------|-----------|-------------|-------|------|------|-----|-----|-----|-----------|
| Ürün Kodu   | Kapak Tipi  | En mm     | Boy mm     | Derinlik mm | Fiyat     |             |       |      |      |     |     |     |           |
| A180  | Opak  | 400       | 500        | 180         |           |             |       |      |      |     |     |     |           |
|    | <table><thead><tr><th>Ürün Kodu</th><th>Kapak Tipi</th><th>En mm</th><th>Boy mm</th><th>Derinlik mm</th><th>Fiyat</th></tr></thead><tbody><tr><td>A240</td><td>Opak</td><td>400</td><td>500</td><td>240</td><td></td></tr></tbody></table>          | Ürün Kodu | Kapak Tipi | En mm       | Boy mm    | Derinlik mm | Fiyat | A240 | Opak | 400 | 500 | 240 |           |
| Ürün Kodu   | Kapak Tipi  | En mm     | Boy mm     | Derinlik mm | Fiyat     |             |       |      |      |     |     |     |           |
| A240  | Opak  | 400       | 500        | 240         |           |             |       |      |      |     |     |     |           |
|   | <table><thead><tr><th>Ürün Kodu</th><th>Kapak Tipi</th><th>En mm</th><th>Boy mm</th><th>Derinlik mm</th><th>Fiyat</th></tr></thead><tbody><tr><td>A200</td><td>Opak</td><td>400</td><td>600</td><td>200</td><td></td></tr></tbody></table>          | Ürün Kodu | Kapak Tipi | En mm       | Boy mm    | Derinlik mm | Fiyat | A200 | Opak | 400 | 600 | 200 |           |
| Ürün Kodu   | Kapak Tipi  | En mm     | Boy mm     | Derinlik mm | Fiyat     |             |       |      |      |     |     |     |           |
| A200  | Opak  | 400       | 600        | 200         |           |             |       |      |      |     |     |     |           |
|  | <table><thead><tr><th>Ürün Kodu</th><th>Kapak Tipi</th><th>En mm</th><th>Boy mm</th><th>Derinlik mm</th><th>Fiyat</th></tr></thead><tbody><tr><td>A250</td><td>Opak</td><td>500</td><td>700</td><td>250</td><td></td></tr></tbody></table>          | Ürün Kodu | Kapak Tipi | En mm       | Boy mm    | Derinlik mm | Fiyat | A250 | Opak | 500 | 700 | 250 |           |
| Ürün Kodu   | Kapak Tipi  | En mm     | Boy mm     | Derinlik mm | Fiyat     |             |       |      |      |     |     |     |           |
| A250  | Opak  | 500       | 700        | 250         |           |             |       |      |      |     |     |     |           |
|  | <table><thead><tr><th>Ürün Kodu</th><th>Kapak Tipi</th><th>En mm</th><th>Boy mm</th><th>Derinlik mm</th><th>Fiyat</th></tr></thead><tbody><tr><td>A280</td><td>Opak</td><td>600</td><td>800</td><td>280</td><td>ASK PRICE</td></tr></tbody></table> | Ürün Kodu | Kapak Tipi | En mm       | Boy mm    | Derinlik mm | Fiyat | A280 | Opak | 600 | 800 | 280 | ASK PRICE |
| Ürün Kodu   | Kapak Tipi  | En mm     | Boy mm     | Derinlik mm | Fiyat     |             |       |      |      |     |     |     |           |
| A280  | Opak  | 600       | 800        | 280         | ASK PRICE |             |       |      |      |     |     |     |           |



# PC PANOLLAR

## Dimensions

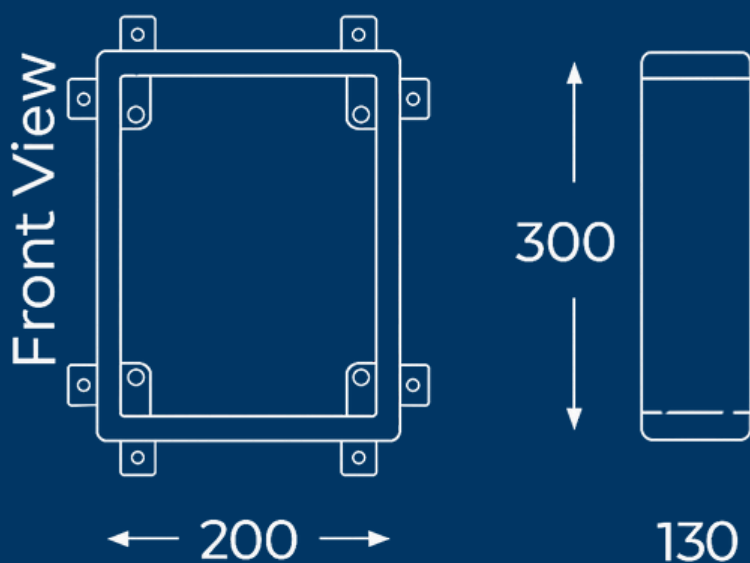

|    | <table border="1"> <thead> <tr> <th>Ürün Kodu</th> <th>Kapak Tipi</th> <th>En mm</th> <th>Boy mm</th> <th>Derinlik mm</th> <th>Fiyat</th> </tr> </thead> <tbody> <tr> <td>P130</td> <td>Şeffaf</td> <td>200</td> <td>300</td> <td>130</td> <td></td> </tr> </tbody> </table>  | Ürün Kodu | Kapak Tipi | En mm       | Boy mm | Derinlik mm | Fiyat | P130 | Şeffaf | 200 | 300 | 130 |  |       |        |     |     |     |  |
|---|---|-----------|------------|-------------|--------|-------------|-------|------|--------|-----|-----|-----|--|-------|--------|-----|-----|-----|--|
| Ürün Kodu   | Kapak Tipi  | En mm     | Boy mm     | Derinlik mm | Fiyat  |             |       |      |        |     |     |     |  |       |        |     |     |     |  |
| P130  | Şeffaf  | 200       | 300        | 130         |        |             |       |      |        |     |     |     |  |       |        |     |     |     |  |
|   | <table border="1"> <thead> <tr> <th>Ürün Kodu</th> <th>Kapak Tipi</th> <th>En mm</th> <th>Boy mm</th> <th>Derinlik mm</th> <th>Fiyat</th> </tr> </thead> <tbody> <tr> <td>P150</td> <td>Şeffaf</td> <td>250</td> <td>350</td> <td>150</td> <td></td> </tr> <tr> <td>EP150</td> <td>Şeffaf</td> <td>250</td> <td>350</td> <td>150</td> <td></td> </tr> </tbody> </table> | Ürün Kodu | Kapak Tipi | En mm       | Boy mm | Derinlik mm | Fiyat | P150 | Şeffaf | 250 | 350 | 150 |  | EP150 | Şeffaf | 250 | 350 | 150 |  |
| Ürün Kodu   | Kapak Tipi  | En mm     | Boy mm     | Derinlik mm | Fiyat  |             |       |      |        |     |     |     |  |       |        |     |     |     |  |
| P150  | Şeffaf  | 250       | 350        | 150         |        |             |       |      |        |     |     |     |  |       |        |     |     |     |  |
| EP150   | Şeffaf  | 250       | 350        | 150         |        |             |       |      |        |     |     |     |  |       |        |     |     |     |  |
|   | <table border="1"> <thead> <tr> <th>Ürün Kodu</th> <th>Kapak Tipi</th> <th>En mm</th> <th>Boy mm</th> <th>Derinlik mm</th> <th>Fiyat</th> </tr> </thead> <tbody> <tr> <td>P210</td> <td>Şeffaf</td> <td>250</td> <td>350</td> <td>210</td> <td></td> </tr> </tbody> </table>  | Ürün Kodu | Kapak Tipi | En mm       | Boy mm | Derinlik mm | Fiyat | P210 | Şeffaf | 250 | 350 | 210 |  |       |        |     |     |     |  |
| Ürün Kodu   | Kapak Tipi  | En mm     | Boy mm     | Derinlik mm | Fiyat  |             |       |      |        |     |     |     |  |       |        |     |     |     |  |
| P210  | Şeffaf  | 250       | 350        | 210         |        |             |       |      |        |     |     |     |  |       |        |     |     |     |  |
|    | <table border="1"> <thead> <tr> <th>Ürün Kodu</th> <th>Kapak Tipi</th> <th>En mm</th> <th>Boy mm</th> <th>Derinlik mm</th> <th>Fiyat</th> </tr> </thead> <tbody> <tr> <td>P170</td> <td>Şeffaf</td> <td>300</td> <td>400</td> <td>170</td> <td></td> </tr> </tbody> </table>  | Ürün Kodu | Kapak Tipi | En mm       | Boy mm | Derinlik mm | Fiyat | P170 | Şeffaf | 300 | 400 | 170 |  |       |        |     |     |     |  |
| Ürün Kodu   | Kapak Tipi  | En mm     | Boy mm     | Derinlik mm | Fiyat  |             |       |      |        |     |     |     |  |       |        |     |     |     |  |
| P170  | Şeffaf  | 300       | 400        | 170         |        |             |       |      |        |     |     |     |  |       |        |     |     |     |  |
|    | <table border="1"> <thead> <tr> <th>Ürün Kodu</th> <th>Kapak Tipi</th> <th>En mm</th> <th>Boy mm</th> <th>Derinlik mm</th> <th>Fiyat</th> </tr> </thead> <tbody> <tr> <td>P220</td> <td>Şeffaf</td> <td>300</td> <td>400</td> <td>220</td> <td></td> </tr> </tbody> </table>  | Ürün Kodu | Kapak Tipi | En mm       | Boy mm | Derinlik mm | Fiyat | P220 | Şeffaf | 300 | 400 | 220 |  |       |        |     |     |     |  |
| Ürün Kodu   | Kapak Tipi  | En mm     | Boy mm     | Derinlik mm | Fiyat  |             |       |      |        |     |     |     |  |       |        |     |     |     |  |
| P220  | Şeffaf  | 300       | 400        | 220         |        |             |       |      |        |     |     |     |  |       |        |     |     |     |  |
|    | <table border="1"> <thead> <tr> <th>Ürün Kodu</th> <th>Kapak Tipi</th> <th>En mm</th> <th>Boy mm</th> <th>Derinlik mm</th> <th>Fiyat</th> </tr> </thead> <tbody> <tr> <td>P190</td> <td>Şeffaf</td> <td>350</td> <td>500</td> <td>190</td> <td></td> </tr> </tbody> </table>  | Ürün Kodu | Kapak Tipi | En mm       | Boy mm | Derinlik mm | Fiyat | P190 | Şeffaf | 350 | 500 | 190 |  |       |        |     |     |     |  |
| Ürün Kodu   | Kapak Tipi  | En mm     | Boy mm     | Derinlik mm | Fiyat  |             |       |      |        |     |     |     |  |       |        |     |     |     |  |
| P190  | Şeffaf  | 350       | 500        | 190         |        |             |       |      |        |     |     |     |  |       |        |     |     |     |  |

|    | <table><thead><tr><th>Ürün Kodu</th><th>Kapak Tipi</th><th>En mm</th><th>Boy mm</th><th>Derinlik mm</th><th>Fiyat</th></tr></thead><tbody><tr><td>P180</td><td>Şeffaf</td><td>400</td><td>500</td><td>180</td><td></td></tr></tbody></table>          | Ürün Kodu | Kapak Tipi | En mm       | Boy mm    | Derinlik mm | Fiyat | P180 | Şeffaf | 400 | 500 | 180 |           |
|---|---|-----------|------------|-------------|-----------|-------------|-------|------|--------|-----|-----|-----|-----------|
| Ürün Kodu   | Kapak Tipi  | En mm     | Boy mm     | Derinlik mm | Fiyat     |             |       |      |        |     |     |     |           |
| P180  | Şeffaf  | 400       | 500        | 180         |           |             |       |      |        |     |     |     |           |
|    | <table><thead><tr><th>Ürün Kodu</th><th>Kapak Tipi</th><th>En mm</th><th>Boy mm</th><th>Derinlik mm</th><th>Fiyat</th></tr></thead><tbody><tr><td>P240</td><td>Şeffaf</td><td>400</td><td>500</td><td>240</td><td></td></tr></tbody></table>          | Ürün Kodu | Kapak Tipi | En mm       | Boy mm    | Derinlik mm | Fiyat | P240 | Şeffaf | 400 | 500 | 240 |           |
| Ürün Kodu   | Kapak Tipi  | En mm     | Boy mm     | Derinlik mm | Fiyat     |             |       |      |        |     |     |     |           |
| P240  | Şeffaf  | 400       | 500        | 240         |           |             |       |      |        |     |     |     |           |
|   | <table><thead><tr><th>Ürün Kodu</th><th>Kapak Tipi</th><th>En mm</th><th>Boy mm</th><th>Derinlik mm</th><th>Fiyat</th></tr></thead><tbody><tr><td>P200</td><td>Şeffaf</td><td>400</td><td>600</td><td>200</td><td></td></tr></tbody></table>          | Ürün Kodu | Kapak Tipi | En mm       | Boy mm    | Derinlik mm | Fiyat | P200 | Şeffaf | 400 | 600 | 200 |           |
| Ürün Kodu   | Kapak Tipi  | En mm     | Boy mm     | Derinlik mm | Fiyat     |             |       |      |        |     |     |     |           |
| P200  | Şeffaf  | 400       | 600        | 200         |           |             |       |      |        |     |     |     |           |
|  | <table><thead><tr><th>Ürün Kodu</th><th>Kapak Tipi</th><th>En mm</th><th>Boy mm</th><th>Derinlik mm</th><th>Fiyat</th></tr></thead><tbody><tr><td>P250</td><td>Şeffaf</td><td>500</td><td>700</td><td>250</td><td></td></tr></tbody></table>          | Ürün Kodu | Kapak Tipi | En mm       | Boy mm    | Derinlik mm | Fiyat | P250 | Şeffaf | 500 | 700 | 250 |           |
| Ürün Kodu   | Kapak Tipi  | En mm     | Boy mm     | Derinlik mm | Fiyat     |             |       |      |        |     |     |     |           |
| P250  | Şeffaf  | 500       | 700        | 250         |           |             |       |      |        |     |     |     |           |
|  | <table><thead><tr><th>Ürün Kodu</th><th>Kapak Tipi</th><th>En mm</th><th>Boy mm</th><th>Derinlik mm</th><th>Fiyat</th></tr></thead><tbody><tr><td>P280</td><td>Şeffaf</td><td>600</td><td>800</td><td>280</td><td>ASK PRICE</td></tr></tbody></table> | Ürün Kodu | Kapak Tipi | En mm       | Boy mm    | Derinlik mm | Fiyat | P280 | Şeffaf | 600 | 800 | 280 | ASK PRICE |
| Ürün Kodu   | Kapak Tipi  | En mm     | Boy mm     | Derinlik mm | Fiyat     |             |       |      |        |     |     |     |           |
| P280  | Şeffaf  | 600       | 800        | 280         | ASK PRICE |             |       |      |        |     |     |     |           |





"Quality in Production, Expertise in Molding"

## MONOFAZE VE TRİFAZE SAYAÇ PANOLARI

| YENİ ÜRÜN | Ürün Kodu | Modül Sayısı | Ölçü | Fiyat |
|-----------|-----------|--------------|------|-------|
|           |           |              |      |       |



Tüm ölçüler mm cinsindedir.

Renk Seçenekleri



[www.akiskalip.com](http://www.akiskalip.com)

|    | <table><thead><tr><th>Ürün Kodu</th><th>Modül Sayısı</th><th>Ölçü</th><th>Fiyat</th></tr></thead><tbody><tr><td>A150F8</td><td>8 Modül</td><td>250*350*150</td><td></td></tr></tbody></table>   | Ürün Kodu   | Modül Sayısı | Ölçü | Fiyat | A150F8  | 8 Modül  | 250*350*150 |  |
|---|---|-------------|--------------|------|-------|---------|----------|-------------|--|
| Ürün Kodu   | Modül Sayısı  | Ölçü        | Fiyat        |      |       |         |          |             |  |
| A150F8  | 8 Modül   | 250*350*150 |              |      |       |         |          |             |  |
|    | <table><thead><tr><th>Ürün Kodu</th><th>Modül Sayısı</th><th>Ölçü</th><th>Fiyat</th></tr></thead><tbody><tr><td>A170F12</td><td>12 Modül</td><td>300*400*170</td><td></td></tr></tbody></table> | Ürün Kodu   | Modül Sayısı | Ölçü | Fiyat | A170F12 | 12 Modül | 300*400*170 |  |
| Ürün Kodu   | Modül Sayısı  | Ölçü        | Fiyat        |      |       |         |          |             |  |
| A170F12   | 12 Modül  | 300*400*170 |              |      |       |         |          |             |  |
|   | <table><thead><tr><th>Ürün Kodu</th><th>Modül Sayısı</th><th>Ölçü</th><th>Fiyat</th></tr></thead><tbody><tr><td>A190F15</td><td>15 Modül</td><td>350*500*190</td><td></td></tr></tbody></table> | Ürün Kodu   | Modül Sayısı | Ölçü | Fiyat | A190F15 | 15 Modül | 350*500*190 |  |
| Ürün Kodu   | Modül Sayısı  | Ölçü        | Fiyat        |      |       |         |          |             |  |
| A190F15   | 15 Modül  | 350*500*190 |              |      |       |         |          |             |  |
|  | <table><thead><tr><th>Ürün Kodu</th><th>Modül Sayısı</th><th>Ölçü</th><th>Fiyat</th></tr></thead><tbody><tr><td>A200F34</td><td>34 Modül</td><td>400*600*200</td><td></td></tr></tbody></table> | Ürün Kodu   | Modül Sayısı | Ölçü | Fiyat | A200F34 | 34 Modül | 400*600*200 |  |
| Ürün Kodu   | Modül Sayısı  | Ölçü        | Fiyat        |      |       |         |          |             |  |
| A200F34   | 34 Modül  | 400*600*200 |              |      |       |         |          |             |  |

|    | <table><thead><tr><th>Ürün Kodu</th><th>Modül Sayısı</th><th>Ölçü</th><th>Fiyat</th></tr></thead><tbody><tr><td>A150F16</td><td>16 Modül</td><td>250*350*150</td><td></td></tr></tbody></table> | Ürün Kodu   | Modül Sayısı | Ölçü | Fiyat | A150F16 | 16 Modül | 250*350*150 |  |
|---|---|-------------|--------------|------|-------|---------|----------|-------------|--|
| Ürün Kodu   | Modül Sayısı  | Ölçü        | Fiyat        |      |       |         |          |             |  |
| A150F16   | 16 Modül  | 250*350*150 |              |      |       |         |          |             |  |
|    | <table><thead><tr><th>Ürün Kodu</th><th>Modül Sayısı</th><th>Ölçü</th><th>Fiyat</th></tr></thead><tbody><tr><td>A170F24</td><td>24 Modül</td><td>300*400*170</td><td></td></tr></tbody></table> | Ürün Kodu   | Modül Sayısı | Ölçü | Fiyat | A170F24 | 24 Modül | 300*400*170 |  |
| Ürün Kodu   | Modül Sayısı  | Ölçü        | Fiyat        |      |       |         |          |             |  |
| A170F24   | 24 Modül  | 300*400*170 |              |      |       |         |          |             |  |
|   | <table><thead><tr><th>Ürün Kodu</th><th>Modül Sayısı</th><th>Ölçü</th><th>Fiyat</th></tr></thead><tbody><tr><td>A190F45</td><td>45 Modül</td><td>350*500*190</td><td></td></tr></tbody></table> | Ürün Kodu   | Modül Sayısı | Ölçü | Fiyat | A190F45 | 45 Modül | 350*500*190 |  |
| Ürün Kodu   | Modül Sayısı  | Ölçü        | Fiyat        |      |       |         |          |             |  |
| A190F45   | 45 Modül  | 350*500*190 |              |      |       |         |          |             |  |
|  | <table><thead><tr><th>Ürün Kodu</th><th>Modül Sayısı</th><th>Ölçü</th><th>Fiyat</th></tr></thead><tbody><tr><td>A200F68</td><td>68 Modül</td><td>400*600*200</td><td></td></tr></tbody></table> | Ürün Kodu   | Modül Sayısı | Ölçü | Fiyat | A200F68 | 68 Modül | 400*600*200 |  |
| Ürün Kodu   | Modül Sayısı  | Ölçü        | Fiyat        |      |       |         |          |             |  |
| A200F68   | 68 Modül  | 400*600*200 |              |      |       |         |          |             |  |

|    | <table><thead><tr><th>Ürün Kodu</th><th>Modül Sayısı</th><th>Ölçü</th><th>Fiyat</th></tr></thead><tbody><tr><td>A190F30</td><td>30 Modül</td><td>350*500*190</td><td></td></tr></tbody></table> | Ürün Kodu   | Modül Sayısı | Ölçü | Fiyat | A190F30 | 30 Modül | 350*500*190 |  |
|---|---|-------------|--------------|------|-------|---------|----------|-------------|--|
| Ürün Kodu   | Modül Sayısı  | Ölçü        | Fiyat        |      |       |         |          |             |  |
| A190F30   | 30 Modül  | 350*500*190 |              |      |       |         |          |             |  |
|    | <table><thead><tr><th>Ürün Kodu</th><th>Modül Sayısı</th><th>Ölçü</th><th>Fiyat</th></tr></thead><tbody><tr><td>A200F17</td><td>17 Modül</td><td>400*600*200</td><td></td></tr></tbody></table> | Ürün Kodu   | Modül Sayısı | Ölçü | Fiyat | A200F17 | 17 Modül | 400*600*200 |  |
| Ürün Kodu   | Modül Sayısı  | Ölçü        | Fiyat        |      |       |         |          |             |  |
| A200F17   | 17 Modül  | 400*600*200 |              |      |       |         |          |             |  |
|   | <table><thead><tr><th>Ürün Kodu</th><th>Modül Sayısı</th><th>Ölçü</th><th>Fiyat</th></tr></thead><tbody><tr><td>A200F34</td><td>34 Modül</td><td>400*600*200</td><td></td></tr></tbody></table> | Ürün Kodu   | Modül Sayısı | Ölçü | Fiyat | A200F34 | 34 Modül | 400*600*200 |  |
| Ürün Kodu   | Modül Sayısı  | Ölçü        | Fiyat        |      |       |         |          |             |  |
| A200F34   | 34 Modül  | 400*600*200 |              |      |       |         |          |             |  |
|  | <table><thead><tr><th>Ürün Kodu</th><th>Modül Sayısı</th><th>Ölçü</th><th>Fiyat</th></tr></thead><tbody><tr><td>A200F51</td><td>51 Modül</td><td>400*600*200</td><td></td></tr></tbody></table> | Ürün Kodu   | Modül Sayısı | Ölçü | Fiyat | A200F51 | 51 Modül | 400*600*200 |  |
| Ürün Kodu   | Modül Sayısı  | Ölçü        | Fiyat        |      |       |         |          |             |  |
| A200F51   | 51 Modül  | 400*600*200 |              |      |       |         |          |             |  |

|    | <table><thead><tr><th>Ürün Kodu</th><th>Modül Sayısı</th><th>Ölçü</th><th>Fiyat</th></tr></thead><tbody><tr><td>P150F8</td><td>8 Modül</td><td>250*350*150</td><td></td></tr></tbody></table>   | Ürün Kodu   | Modül Sayısı | Ölçü | Fiyat | P150F8  | 8 Modül  | 250*350*150 |  |
|---|---|-------------|--------------|------|-------|---------|----------|-------------|--|
| Ürün Kodu   | Modül Sayısı  | Ölçü        | Fiyat        |      |       |         |          |             |  |
| P150F8  | 8 Modül   | 250*350*150 |              |      |       |         |          |             |  |
|    | <table><thead><tr><th>Ürün Kodu</th><th>Modül Sayısı</th><th>Ölçü</th><th>Fiyat</th></tr></thead><tbody><tr><td>P170F12</td><td>12 Modül</td><td>300*400*170</td><td></td></tr></tbody></table> | Ürün Kodu   | Modül Sayısı | Ölçü | Fiyat | P170F12 | 12 Modül | 300*400*170 |  |
| Ürün Kodu   | Modül Sayısı  | Ölçü        | Fiyat        |      |       |         |          |             |  |
| P170F12   | 12 Modül  | 300*400*170 |              |      |       |         |          |             |  |
|   | <table><thead><tr><th>Ürün Kodu</th><th>Modül Sayısı</th><th>Ölçü</th><th>Fiyat</th></tr></thead><tbody><tr><td>P190F15</td><td>15 Modül</td><td>350*500*190</td><td></td></tr></tbody></table> | Ürün Kodu   | Modül Sayısı | Ölçü | Fiyat | P190F15 | 15 Modül | 350*500*190 |  |
| Ürün Kodu   | Modül Sayısı  | Ölçü        | Fiyat        |      |       |         |          |             |  |
| P190F15   | 15 Modül  | 350*500*190 |              |      |       |         |          |             |  |
|  | <table><thead><tr><th>Ürün Kodu</th><th>Modül Sayısı</th><th>Ölçü</th><th>Fiyat</th></tr></thead><tbody><tr><td>P200F34</td><td>34 Modül</td><td>400*600*200</td><td></td></tr></tbody></table> | Ürün Kodu   | Modül Sayısı | Ölçü | Fiyat | P200F34 | 34 Modül | 400*600*200 |  |
| Ürün Kodu   | Modül Sayısı  | Ölçü        | Fiyat        |      |       |         |          |             |  |
| P200F34   | 34 Modül  | 400*600*200 |              |      |       |         |          |             |  |





|    | <table><thead><tr><th>Ürün Kodu</th><th>Modül Sayısı</th><th>Ölçü</th><th>Fiyat</th></tr></thead><tbody><tr><td>P150F16</td><td>16 Modül</td><td>250*350*150</td><td></td></tr></tbody></table> | Ürün Kodu   | Modül Sayısı | Ölçü | Fiyat | P150F16 | 16 Modül | 250*350*150 |  |
|---|---|-------------|--------------|------|-------|---------|----------|-------------|--|
| Ürün Kodu   | Modül Sayısı  | Ölçü        | Fiyat        |      |       |         |          |             |  |
| P150F16   | 16 Modül  | 250*350*150 |              |      |       |         |          |             |  |
|    | <table><thead><tr><th>Ürün Kodu</th><th>Modül Sayısı</th><th>Ölçü</th><th>Fiyat</th></tr></thead><tbody><tr><td>P170F24</td><td>24 Modül</td><td>300*400*170</td><td></td></tr></tbody></table> | Ürün Kodu   | Modül Sayısı | Ölçü | Fiyat | P170F24 | 24 Modül | 300*400*170 |  |
| Ürün Kodu   | Modül Sayısı  | Ölçü        | Fiyat        |      |       |         |          |             |  |
| P170F24   | 24 Modül  | 300*400*170 |              |      |       |         |          |             |  |
|   | <table><thead><tr><th>Ürün Kodu</th><th>Modül Sayısı</th><th>Ölçü</th><th>Fiyat</th></tr></thead><tbody><tr><td>P190F45</td><td>45 Modül</td><td>350*500*190</td><td></td></tr></tbody></table> | Ürün Kodu   | Modül Sayısı | Ölçü | Fiyat | P190F45 | 45 Modül | 350*500*190 |  |
| Ürün Kodu   | Modül Sayısı  | Ölçü        | Fiyat        |      |       |         |          |             |  |
| P190F45   | 45 Modül  | 350*500*190 |              |      |       |         |          |             |  |
|  | <table><thead><tr><th>Ürün Kodu</th><th>Modül Sayısı</th><th>Ölçü</th><th>Fiyat</th></tr></thead><tbody><tr><td>P200F68</td><td>68 Modül</td><td>400*600*200</td><td></td></tr></tbody></table> | Ürün Kodu   | Modül Sayısı | Ölçü | Fiyat | P200F68 | 68 Modül | 400*600*200 |  |
| Ürün Kodu   | Modül Sayısı  | Ölçü        | Fiyat        |      |       |         |          |             |  |
| P200F68   | 68 Modül  | 400*600*200 |              |      |       |         |          |             |  |

|    | <table><thead><tr><th>Ürün Kodu</th><th>Modül Sayısı</th><th>Ölçü</th><th>Fiyat</th></tr></thead><tbody><tr><td>P190F30</td><td>30 Modül</td><td>350*500*190</td><td></td></tr></tbody></table> | Ürün Kodu   | Modül Sayısı | Ölçü | Fiyat | P190F30 | 30 Modül | 350*500*190 |  |
|---|---|-------------|--------------|------|-------|---------|----------|-------------|--|
| Ürün Kodu   | Modül Sayısı  | Ölçü        | Fiyat        |      |       |         |          |             |  |
| P190F30   | 30 Modül  | 350*500*190 |              |      |       |         |          |             |  |
|    | <table><thead><tr><th>Ürün Kodu</th><th>Modül Sayısı</th><th>Ölçü</th><th>Fiyat</th></tr></thead><tbody><tr><td>P200F17</td><td>17 Modül</td><td>400*600*200</td><td></td></tr></tbody></table> | Ürün Kodu   | Modül Sayısı | Ölçü | Fiyat | P200F17 | 17 Modül | 400*600*200 |  |
| Ürün Kodu   | Modül Sayısı  | Ölçü        | Fiyat        |      |       |         |          |             |  |
| P200F17   | 17 Modül  | 400*600*200 |              |      |       |         |          |             |  |
|   | <table><thead><tr><th>Ürün Kodu</th><th>Modül Sayısı</th><th>Ölçü</th><th>Fiyat</th></tr></thead><tbody><tr><td>P200F34</td><td>34 Modül</td><td>400*600*200</td><td></td></tr></tbody></table> | Ürün Kodu   | Modül Sayısı | Ölçü | Fiyat | P200F34 | 34 Modül | 400*600*200 |  |
| Ürün Kodu   | Modül Sayısı  | Ölçü        | Fiyat        |      |       |         |          |             |  |
| P200F34   | 34 Modül  | 400*600*200 |              |      |       |         |          |             |  |
|  | <table><thead><tr><th>Ürün Kodu</th><th>Modül Sayısı</th><th>Ölçü</th><th>Fiyat</th></tr></thead><tbody><tr><td>P200F51</td><td>51 Modül</td><td>400*600*200</td><td></td></tr></tbody></table> | Ürün Kodu   | Modül Sayısı | Ölçü | Fiyat | P200F51 | 51 Modül | 400*600*200 |  |
| Ürün Kodu   | Modül Sayısı  | Ölçü        | Fiyat        |      |       |         |          |             |  |
| P200F51   | 51 Modül  | 400*600*200 |              |      |       |         |          |             |  |

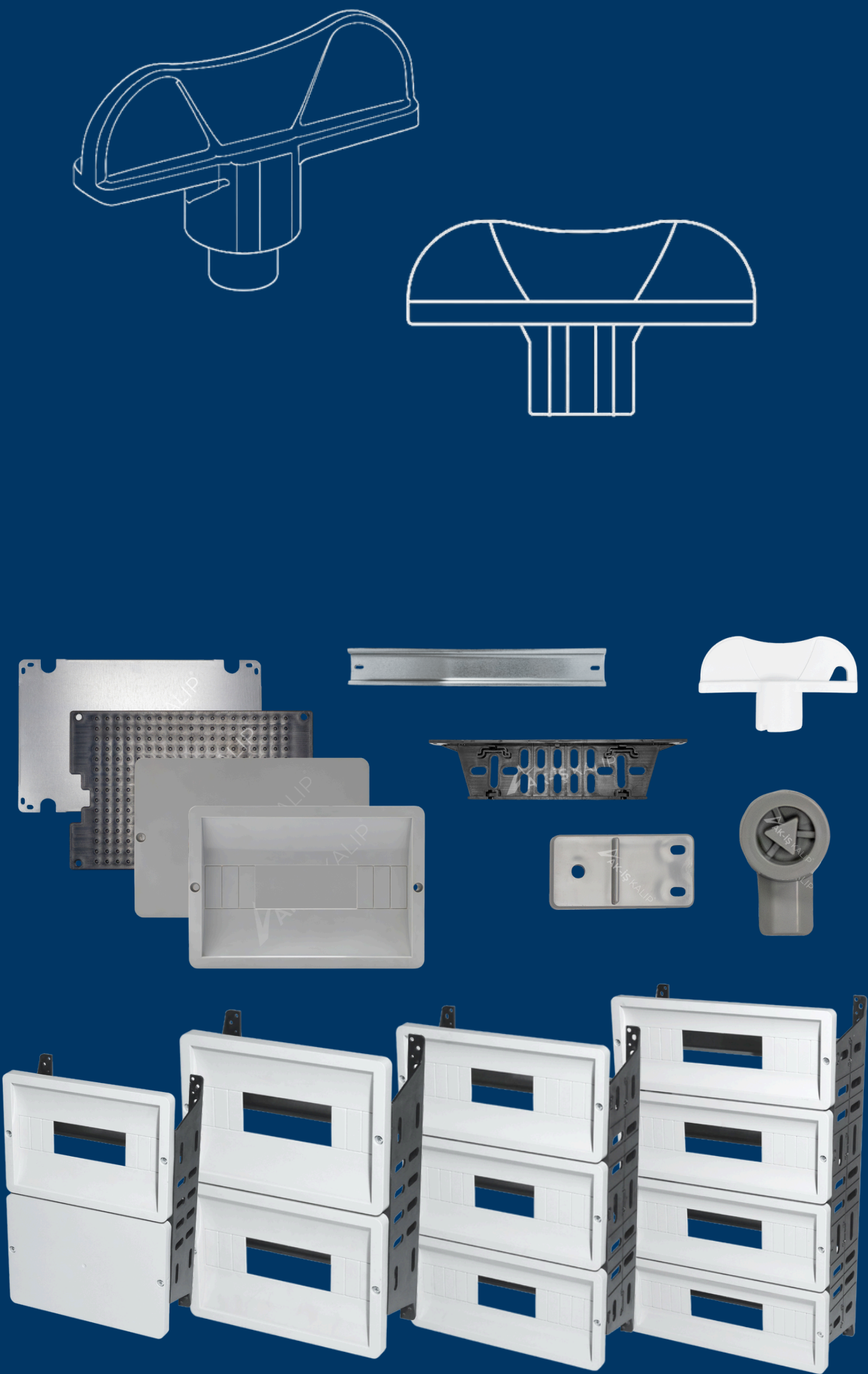
# TAMAMLAYICI ÜRÜNLER

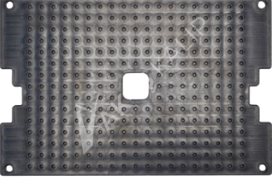

|    | Ürün                 | Ürün Kodu | Ölçü     | Fiyat |
|---|----------------------|-----------|----------|-------|
|   | Taban Sacı           | SC-130    | 200*300  |       |
|   | Taban Sacı           | SC-150    | 250*350  |       |
|   | Taban Sacı           | SC-170    | 300*400  |       |
|   | Taban Sacı           | SC-190    | 350*500  |       |
|   | Taban Sacı           | SC-180    | 400*500  |       |
|   | Taban Sacı           | SC-200    | 400*600  |       |
|   | Taban Sacı           | SC-250    | 500*700  |       |
|   | Ürün                 | Ürün Kodu | Hammadde | Fiyat |
|   | Pano Anahtar         | PA-1      | ABS      |       |
|  | Ürün                 | Ürün Kodu | Hammadde | Fiyat |
|   | Duvar Montaj Aparatı | DM-1      | ABS      |       |
|  | Ürün                 | Ürün Kodu | Hammadde | Fiyat |
|   | Pano Kilit           | PK-1      | ABS      |       |

|    | Ürün              | Ürün Kodu | Hammadde | Fiyat |
|---|-------------------|-----------|----------|-------|
|   | Yan Plastik Dikme | PYP 150   | ABS      |       |
|   | Yan Plastik Dikme | PYP 170   | ABS      |       |
|   | Yan Plastik Dikme | PYP 190   | ABS      |       |
|    | Ürün              | Ürün Kodu | Hammadde | Fiyat |
|   | Ray Sacı          | PRY 150   | ABS      |       |
|   | Ray Sacı          | PRY 170   | ABS      |       |
|   | Ray Sacı          | PRY 190   | ABS      |       |
|  | Ürün              | Ürün Kodu | Hammadde | Fiyat |
|   | Perde Plastik     | PSP 150   | ABS      |       |
|   | Perde Plastik     | PSP 170   | ABS      |       |
|   | Perde Plastik     | PSP 190   | ABS      |       |
|  | Ürün              | Ürün Kodu | Hammadde | Fiyat |
|   | Düz Perde Plastik | PDP 150   | ABS      |       |
|   | Düz Perde Plastik | PDP 170   | ABS      |       |
|   | Düz Perde Plastik | PDP 190   | ABS      |       |
|  | Ürün              | Ürün Kodu | Hammadde | Fiyat |
|   | Taban Plastik     | PTP 150   | ABS      |       |
|   | Taban Plastik     | PTP 170   | ABS      |       |
|   | Taban Plastik     | PTP 190   | ABS      |       |
|  | Ürün              | Ürün Kodu | Hammadde | Fiyat |
|   | Taban Plastik     | PTP 200   | ABS      |       |
|   | Taban Plastik     | PTP 150   | ABS      |       |
|   | Taban Plastik     | PTP 170   | ABS      |       |

# TERMOPLASTİK BUATLAR

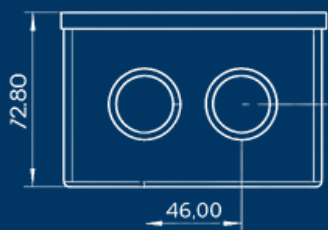

RIGHT

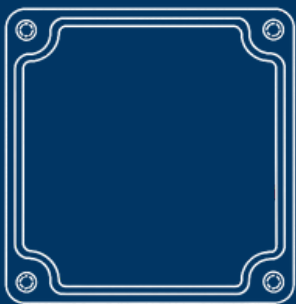

FRONT

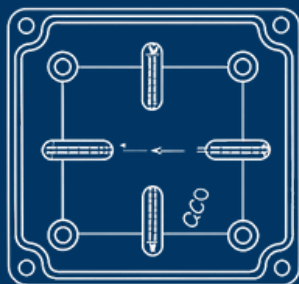

INSIDE



|    | <table><thead><tr><th>Ürün Kodu</th><th>Koli İçi Adet</th><th>Ölçü</th><th>Hammadde</th><th>Fiyat</th></tr></thead><tbody><tr><td>85.SOFT-01</td><td>200 Adet</td><td>85*85*<b>40</b></td><td>ABS</td><td></td></tr></tbody></table> | Ürün Kodu          | Koli İçi Adet | Ölçü  | Hammadde | Fiyat | 85.SOFT-01 | 200 Adet | 85*85* <b>40</b>   | ABS |  |
|---|--|--------------------|---------------|-------|----------|-------|------------|----------|--------------------|-----|--|
| Ürün Kodu   | Koli İçi Adet  | Ölçü               | Hammadde      | Fiyat |          |       |            |          |                    |     |  |
| 85.SOFT-01  | 200 Adet   | 85*85* <b>40</b>   | ABS           |       |          |       |            |          |                    |     |  |
|    | <table><thead><tr><th>Ürün Kodu</th><th>Koli İçi Adet</th><th>Ölçü</th><th>Hammadde</th><th>Fiyat</th></tr></thead><tbody><tr><td>1800-01</td><td>60 Adet</td><td>85*85*<b>40</b></td><td>ABS</td><td></td></tr></tbody></table>     | Ürün Kodu          | Koli İçi Adet | Ölçü  | Hammadde | Fiyat | 1800-01    | 60 Adet  | 85*85* <b>40</b>   | ABS |  |
| Ürün Kodu   | Koli İçi Adet  | Ölçü               | Hammadde      | Fiyat |          |       |            |          |                    |     |  |
| 1800-01   | 60 Adet  | 85*85* <b>40</b>   | ABS           |       |          |       |            |          |                    |     |  |
|  | <table><thead><tr><th>Ürün Kodu</th><th>Koli İçi Adet</th><th>Ölçü</th><th>Hammadde</th><th>Fiyat</th></tr></thead><tbody><tr><td>1805-01</td><td>50 Adet</td><td>85*85*<b>40</b></td><td>ABS</td><td></td></tr></tbody></table>     | Ürün Kodu          | Koli İçi Adet | Ölçü  | Hammadde | Fiyat | 1805-01    | 50 Adet  | 85*85* <b>40</b>   | ABS |  |
| Ürün Kodu   | Koli İçi Adet  | Ölçü               | Hammadde      | Fiyat |          |       |            |          |                    |     |  |
| 1805-01   | 50 Adet  | 85*85* <b>40</b>   | ABS           |       |          |       |            |          |                    |     |  |
|  | <table><thead><tr><th>Ürün Kodu</th><th>Koli İçi Adet</th><th>Ölçü</th><th>Hammadde</th><th>Fiyat</th></tr></thead><tbody><tr><td>1810-11</td><td>48 Adet</td><td>110*110*<b>72</b></td><td>ABS</td><td></td></tr></tbody></table>   | Ürün Kodu          | Koli İçi Adet | Ölçü  | Hammadde | Fiyat | 1810-11    | 48 Adet  | 110*110* <b>72</b> | ABS |  |
| Ürün Kodu   | Koli İçi Adet  | Ölçü               | Hammadde      | Fiyat |          |       |            |          |                    |     |  |
| 1810-11   | 48 Adet  | 110*110* <b>72</b> | ABS           |       |          |       |            |          |                    |     |  |
|  | <table><thead><tr><th>Ürün Kodu</th><th>Koli İçi Adet</th><th>Ölçü</th><th>Hammadde</th><th>Fiyat</th></tr></thead><tbody><tr><td>1810-33</td><td>48 Adet</td><td>110*110*<b>97</b></td><td>ABS</td><td></td></tr></tbody></table>   | Ürün Kodu          | Koli İçi Adet | Ölçü  | Hammadde | Fiyat | 1810-33    | 48 Adet  | 110*110* <b>97</b> | ABS |  |
| Ürün Kodu   | Koli İçi Adet  | Ölçü               | Hammadde      | Fiyat |          |       |            |          |                    |     |  |
| 1810-33   | 48 Adet  | 110*110* <b>97</b> | ABS           |       |          |       |            |          |                    |     |  |

|    | <table><thead><tr><th>Ürün Kodu</th><th>Koli İçi Adet</th><th>Ölçü</th><th>Hammadde</th><th>Fiyat</th></tr></thead><tbody><tr><td>1810-55</td><td>48 Adet</td><td>110*110*<b>122</b></td><td>ABS</td><td></td></tr></tbody></table> | Ürün Kodu           | Koli İçi Adet | Ölçü  | Hammadde | Fiyat | 1810-55 | 48 Adet | 110*110* <b>122</b> | ABS |  |
|---|---|---------------------|---------------|-------|----------|-------|---------|---------|---------------------|-----|--|
| Ürün Kodu   | Koli İçi Adet   | Ölçü                | Hammadde      | Fiyat |          |       |         |         |                     |     |  |
| 1810-55   | 48 Adet   | 110*110* <b>122</b> | ABS           |       |          |       |         |         |                     |     |  |
|    | <table><thead><tr><th>Ürün Kodu</th><th>Koli İçi Adet</th><th>Ölçü</th><th>Hammadde</th><th>Fiyat</th></tr></thead><tbody><tr><td>1810-77</td><td>36 Adet</td><td>110*110*<b>147</b></td><td>ABS</td><td></td></tr></tbody></table> | Ürün Kodu           | Koli İçi Adet | Ölçü  | Hammadde | Fiyat | 1810-77 | 36 Adet | 110*110* <b>147</b> | ABS |  |
| Ürün Kodu   | Koli İçi Adet   | Ölçü                | Hammadde      | Fiyat |          |       |         |         |                     |     |  |
| 1810-77   | 36 Adet   | 110*110* <b>147</b> | ABS           |       |          |       |         |         |                     |     |  |
|   | <table><thead><tr><th>Ürün Kodu</th><th>Koli İçi Adet</th><th>Ölçü</th><th>Hammadde</th><th>Fiyat</th></tr></thead><tbody><tr><td>1811-01</td><td>24 Adet</td><td>110*220*<b>72</b></td><td>ABS</td><td></td></tr></tbody></table>  | Ürün Kodu           | Koli İçi Adet | Ölçü  | Hammadde | Fiyat | 1811-01 | 24 Adet | 110*220* <b>72</b>  | ABS |  |
| Ürün Kodu   | Koli İçi Adet   | Ölçü                | Hammadde      | Fiyat |          |       |         |         |                     |     |  |
| 1811-01   | 24 Adet   | 110*220* <b>72</b>  | ABS           |       |          |       |         |         |                     |     |  |
|   | <table><thead><tr><th>Ürün Kodu</th><th>Koli İçi Adet</th><th>Ölçü</th><th>Hammadde</th><th>Fiyat</th></tr></thead><tbody><tr><td>1811-05</td><td>24 Adet</td><td>110*220*<b>122</b></td><td>ABS</td><td></td></tr></tbody></table> | Ürün Kodu           | Koli İçi Adet | Ölçü  | Hammadde | Fiyat | 1811-05 | 24 Adet | 110*220* <b>122</b> | ABS |  |
| Ürün Kodu   | Koli İçi Adet   | Ölçü                | Hammadde      | Fiyat |          |       |         |         |                     |     |  |
| 1811-05   | 24 Adet   | 110*220* <b>122</b> | ABS           |       |          |       |         |         |                     |     |  |
|  | <table><thead><tr><th>Ürün Kodu</th><th>Koli İçi Adet</th><th>Ölçü</th><th>Hammadde</th><th>Fiyat</th></tr></thead><tbody><tr><td>1815-02</td><td>24 Adet</td><td>150*150*<b>80</b></td><td>ABS</td><td></td></tr></tbody></table>  | Ürün Kodu           | Koli İçi Adet | Ölçü  | Hammadde | Fiyat | 1815-02 | 24 Adet | 150*150* <b>80</b>  | ABS |  |
| Ürün Kodu   | Koli İçi Adet   | Ölçü                | Hammadde      | Fiyat |          |       |         |         |                     |     |  |
| 1815-02   | 24 Adet   | 150*150* <b>80</b>  | ABS           |       |          |       |         |         |                     |     |  |



# KABLO KANALLARI

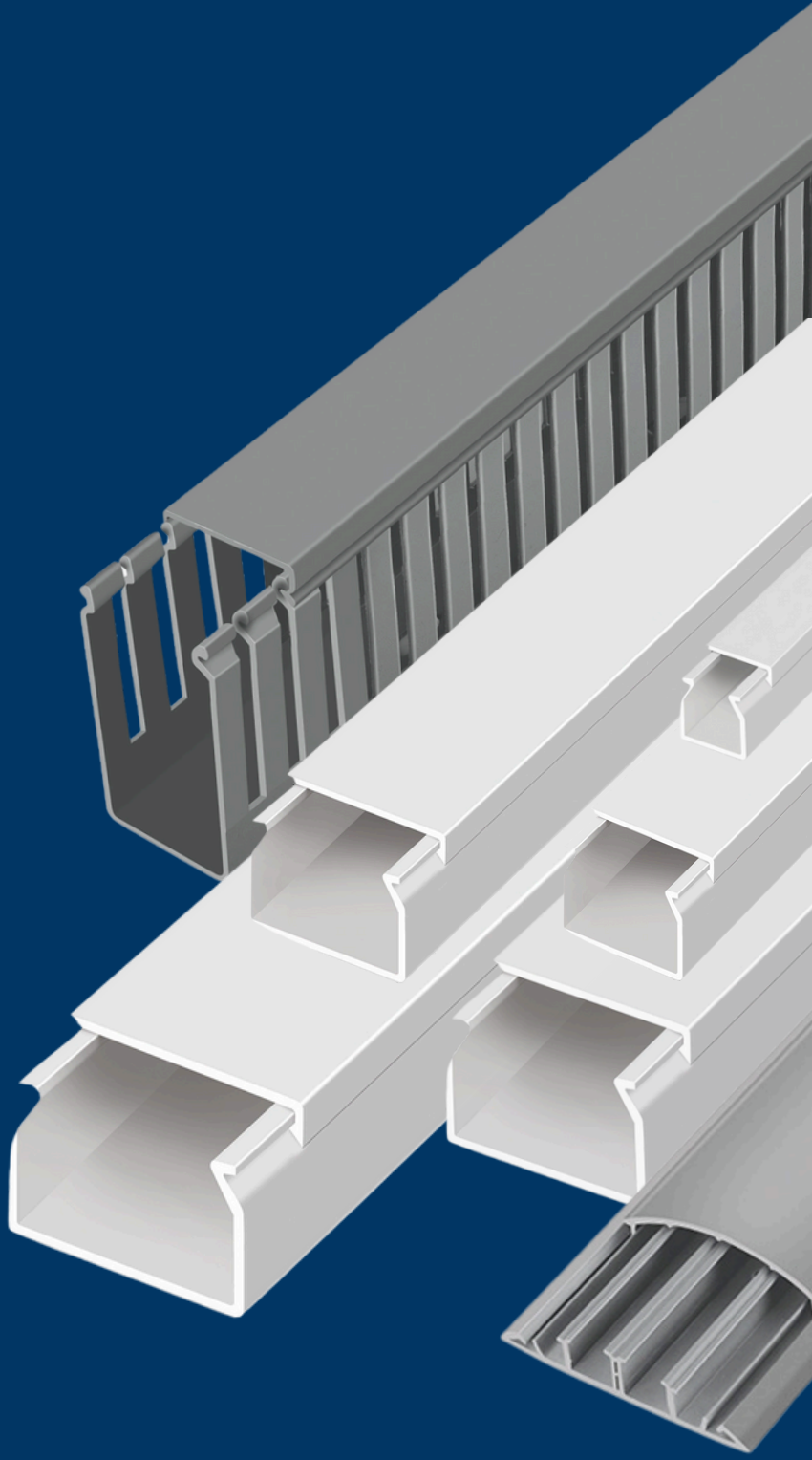
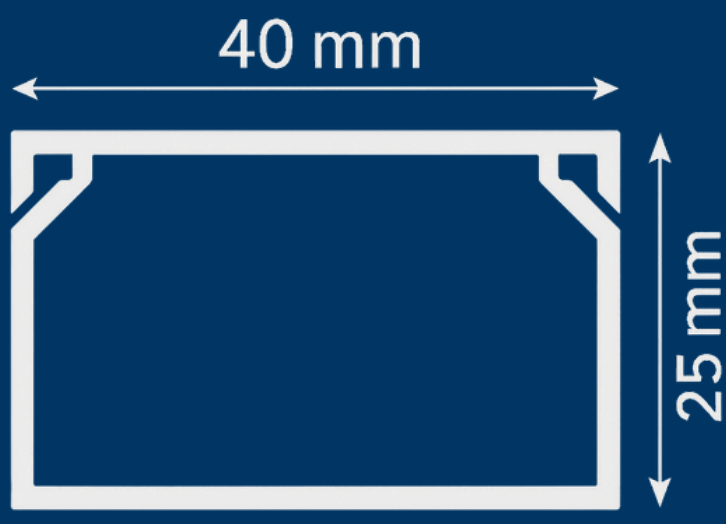

|    | <table><thead><tr><th>Ürün Kodu</th><th>Ölçü</th><th>Kutu İçi Metraj</th><th>Fiyat</th></tr></thead><tbody><tr><td>AK12-12</td><td>12 x 12</td><td>412 mt.</td><td></td></tr></tbody></table> | Ürün Kodu       | Ölçü  | Kutu İçi Metraj | Fiyat | AK12-12 | 12 x 12 | 412 mt. |  |
|--|---|-----------------|-------|-----------------|-------|---------|---------|---------|--|
| Ürün Kodu  | Ölçü  | Kutu İçi Metraj | Fiyat |                 |       |         |         |         |  |
| AK12-12  | 12 x 12   | 412 mt.         |       |                 |       |         |         |         |  |
|    | <table><thead><tr><th>Ürün Kodu</th><th>Ölçü</th><th>Kutu İçi Metraj</th><th>Fiyat</th></tr></thead><tbody><tr><td>AK15-10</td><td>15 x 10</td><td>412 mt.</td><td></td></tr></tbody></table> | Ürün Kodu       | Ölçü  | Kutu İçi Metraj | Fiyat | AK15-10 | 15 x 10 | 412 mt. |  |
| Ürün Kodu  | Ölçü  | Kutu İçi Metraj | Fiyat |                 |       |         |         |         |  |
| AK15-10  | 15 x 10   | 412 mt.         |       |                 |       |         |         |         |  |
|   | <table><thead><tr><th>Ürün Kodu</th><th>Ölçü</th><th>Kutu İçi Metraj</th><th>Fiyat</th></tr></thead><tbody><tr><td>AK16-16</td><td>16 x 16</td><td>266 mt.</td><td></td></tr></tbody></table> | Ürün Kodu       | Ölçü  | Kutu İçi Metraj | Fiyat | AK16-16 | 16 x 16 | 266 mt. |  |
| Ürün Kodu  | Ölçü  | Kutu İçi Metraj | Fiyat |                 |       |         |         |         |  |
| AK16-16  | 16 x 16   | 266 mt.         |       |                 |       |         |         |         |  |
|  | <table><thead><tr><th>Ürün Kodu</th><th>Ölçü</th><th>Kutu İçi Metraj</th><th>Fiyat</th></tr></thead><tbody><tr><td>AK20-10</td><td>20 x 10</td><td>280 mt.</td><td></td></tr></tbody></table> | Ürün Kodu       | Ölçü  | Kutu İçi Metraj | Fiyat | AK20-10 | 20 x 10 | 280 mt. |  |
| Ürün Kodu  | Ölçü  | Kutu İçi Metraj | Fiyat |                 |       |         |         |         |  |
| AK20-10  | 20 x 10   | 280 mt.         |       |                 |       |         |         |         |  |
|  | <table><thead><tr><th>Ürün Kodu</th><th>Ölçü</th><th>Kutu İçi Metraj</th><th>Fiyat</th></tr></thead><tbody><tr><td>AK25-16</td><td>25 x 16</td><td>154 mt.</td><td></td></tr></tbody></table> | Ürün Kodu       | Ölçü  | Kutu İçi Metraj | Fiyat | AK25-16 | 25 x 16 | 154 mt. |  |
| Ürün Kodu  | Ölçü  | Kutu İçi Metraj | Fiyat |                 |       |         |         |         |  |
| AK25-16  | 25 x 16   | 154 mt.         |       |                 |       |         |         |         |  |
|  | <table><thead><tr><th>Ürün Kodu</th><th>Ölçü</th><th>Kutu İçi Metraj</th><th>Fiyat</th></tr></thead><tbody><tr><td>AK25-25</td><td>25 x 25</td><td>96 mt.</td><td></td></tr></tbody></table>  | Ürün Kodu       | Ölçü  | Kutu İçi Metraj | Fiyat | AK25-25 | 25 x 25 | 96 mt.  |  |
| Ürün Kodu  | Ölçü  | Kutu İçi Metraj | Fiyat |                 |       |         |         |         |  |
| AK25-25  | 25 x 25   | 96 mt.          |       |                 |       |         |         |         |  |

|    | <table><thead><tr><th>Ürün Kodu</th><th>Ölçü</th><th>Kutu İçi Metraj</th><th>Fiyat</th></tr></thead><tbody><tr><td>AK30-20</td><td>30 x 20</td><td>108 mt.</td><td></td></tr></tbody></table> | Ürün Kodu       | Ölçü  | Kutu İçi Metraj | Fiyat | AK30-20 | 30 x 20 | 108 mt. |  |
|--|---|-----------------|-------|-----------------|-------|---------|---------|---------|--|
| Ürün Kodu  | Ölçü  | Kutu İçi Metraj | Fiyat |                 |       |         |         |         |  |
| AK30-20  | 30 x 20   | 108 mt.         |       |                 |       |         |         |         |  |
|    | <table><thead><tr><th>Ürün Kodu</th><th>Ölçü</th><th>Kutu İçi Metraj</th><th>Fiyat</th></tr></thead><tbody><tr><td>AK40-16</td><td>40 x 16</td><td>98 mt.</td><td></td></tr></tbody></table>  | Ürün Kodu       | Ölçü  | Kutu İçi Metraj | Fiyat | AK40-16 | 40 x 16 | 98 mt.  |  |
| Ürün Kodu  | Ölçü  | Kutu İçi Metraj | Fiyat |                 |       |         |         |         |  |
| AK40-16  | 40 x 16   | 98 mt.          |       |                 |       |         |         |         |  |
|   | <table><thead><tr><th>Ürün Kodu</th><th>Ölçü</th><th>Kutu İçi Metraj</th><th>Fiyat</th></tr></thead><tbody><tr><td>AK40-25</td><td>40 x 25</td><td>70 mt.</td><td></td></tr></tbody></table>  | Ürün Kodu       | Ölçü  | Kutu İçi Metraj | Fiyat | AK40-25 | 40 x 25 | 70 mt.  |  |
| Ürün Kodu  | Ölçü  | Kutu İçi Metraj | Fiyat |                 |       |         |         |         |  |
| AK40-25  | 40 x 25   | 70 mt.          |       |                 |       |         |         |         |  |
|  | <table><thead><tr><th>Ürün Kodu</th><th>Ölçü</th><th>Kutu İçi Metraj</th><th>Fiyat</th></tr></thead><tbody><tr><td>AK40-40</td><td>40 x 40</td><td>72 mt.</td><td></td></tr></tbody></table>  | Ürün Kodu       | Ölçü  | Kutu İçi Metraj | Fiyat | AK40-40 | 40 x 40 | 72 mt.  |  |
| Ürün Kodu  | Ölçü  | Kutu İçi Metraj | Fiyat |                 |       |         |         |         |  |
| AK40-40  | 40 x 40   | 72 mt.          |       |                 |       |         |         |         |  |
|  | <table><thead><tr><th>Ürün Kodu</th><th>Ölçü</th><th>Kutu İçi Metraj</th><th>Fiyat</th></tr></thead><tbody><tr><td>AK50-50</td><td>50 x 50</td><td>24 mt.</td><td></td></tr></tbody></table>  | Ürün Kodu       | Ölçü  | Kutu İçi Metraj | Fiyat | AK50-50 | 50 x 50 | 24 mt.  |  |
| Ürün Kodu  | Ölçü  | Kutu İçi Metraj | Fiyat |                 |       |         |         |         |  |
| AK50-50  | 50 x 50   | 24 mt.          |       |                 |       |         |         |         |  |
|  | <table><thead><tr><th>Ürün Kodu</th><th>Ölçü</th><th>Kutu İçi Metraj</th><th>Fiyat</th></tr></thead><tbody><tr><td>AK60-40</td><td>60 x 40</td><td>48 mt.</td><td></td></tr></tbody></table>  | Ürün Kodu       | Ölçü  | Kutu İçi Metraj | Fiyat | AK60-40 | 60 x 40 | 48 mt.  |  |
| Ürün Kodu  | Ölçü  | Kutu İçi Metraj | Fiyat |                 |       |         |         |         |  |
| AK60-40  | 60 x 40   | 48 mt.          |       |                 |       |         |         |         |  |

|    | <table><thead><tr><th>Ürün Kodu</th><th>Ölçü</th><th>Kutu İçi Metraj</th><th>Fiyat</th></tr></thead><tbody><tr><td>AK60-60</td><td>60 x 60</td><td>40 mt.</td><td></td></tr></tbody></table>    | Ürün Kodu       | Ölçü  | Kutu İçi Metraj | Fiyat | AK60-60   | 60 x 60   | 40 mt. |  |
|--|---|-----------------|-------|-----------------|-------|-----------|-----------|--------|--|
| Ürün Kodu  | Ölçü  | Kutu İçi Metraj | Fiyat |                 |       |           |           |        |  |
| AK60-60  | 60 x 60   | 40 mt.          |       |                 |       |           |           |        |  |
|    | <table><thead><tr><th>Ürün Kodu</th><th>Ölçü</th><th>Kutu İçi Metraj</th><th>Fiyat</th></tr></thead><tbody><tr><td>AK75-75</td><td>75 x 75</td><td>18 mt.</td><td></td></tr></tbody></table>    | Ürün Kodu       | Ölçü  | Kutu İçi Metraj | Fiyat | AK75-75   | 75 x 75   | 18 mt. |  |
| Ürün Kodu  | Ölçü  | Kutu İçi Metraj | Fiyat |                 |       |           |           |        |  |
| AK75-75  | 75 x 75   | 18 mt.          |       |                 |       |           |           |        |  |
|   | <table><thead><tr><th>Ürün Kodu</th><th>Ölçü</th><th>Kutu İçi Metraj</th><th>Fiyat</th></tr></thead><tbody><tr><td>AK80-40</td><td>80 x 40</td><td>36 mt.</td><td></td></tr></tbody></table>    | Ürün Kodu       | Ölçü  | Kutu İçi Metraj | Fiyat | AK80-40   | 80 x 40   | 36 mt. |  |
| Ürün Kodu  | Ölçü  | Kutu İçi Metraj | Fiyat |                 |       |           |           |        |  |
| AK80-40  | 80 x 40   | 36 mt.          |       |                 |       |           |           |        |  |
|  | <table><thead><tr><th>Ürün Kodu</th><th>Ölçü</th><th>Kutu İçi Metraj</th><th>Fiyat</th></tr></thead><tbody><tr><td>AK80-60</td><td>80 x 60</td><td>32 mt.</td><td></td></tr></tbody></table>    | Ürün Kodu       | Ölçü  | Kutu İçi Metraj | Fiyat | AK80-60   | 80 x 60   | 32 mt. |  |
| Ürün Kodu  | Ölçü  | Kutu İçi Metraj | Fiyat |                 |       |           |           |        |  |
| AK80-60  | 80 x 60   | 32 mt.          |       |                 |       |           |           |        |  |
|  | <table><thead><tr><th>Ürün Kodu</th><th>Ölçü</th><th>Kutu İçi Metraj</th><th>Fiyat</th></tr></thead><tbody><tr><td>AK100-40</td><td>100 x 40</td><td>28 mt.</td><td></td></tr></tbody></table>  | Ürün Kodu       | Ölçü  | Kutu İçi Metraj | Fiyat | AK100-40  | 100 x 40  | 28 mt. |  |
| Ürün Kodu  | Ölçü  | Kutu İçi Metraj | Fiyat |                 |       |           |           |        |  |
| AK100-40   | 100 x 40  | 28 mt.          |       |                 |       |           |           |        |  |
|  | <table><thead><tr><th>Ürün Kodu</th><th>Ölçü</th><th>Kutu İçi Metraj</th><th>Fiyat</th></tr></thead><tbody><tr><td>AK100-100</td><td>100 x 100</td><td>8 mt.</td><td></td></tr></tbody></table> | Ürün Kodu       | Ölçü  | Kutu İçi Metraj | Fiyat | AK100-100 | 100 x 100 | 8 mt.  |  |
| Ürün Kodu  | Ölçü  | Kutu İçi Metraj | Fiyat |                 |       |           |           |        |  |
| AK100-100  | 100 x 100   | 8 mt.           |       |                 |       |           |           |        |  |

# YAPIŞKANLI KABLO KANALLARI



| Ürün Kodu | Ölçü    | Kutu İçi Metraj | Fiyat |
|-----------|---------|-----------------|-------|
| AKB12-12  | 12 x 12 | 412 mt.         |       |



| Ürün Kodu | Ölçü    | Kutu İçi Metraj | Fiyat |
|-----------|---------|-----------------|-------|
| AKB15-10  | 15 x 10 | 412 mt.         |       |



| Ürün Kodu | Ölçü    | Kutu İçi Metraj | Fiyat |
|-----------|---------|-----------------|-------|
| AKB16-16  | 16 x 16 | 250 mt.         |       |



| Ürün Kodu | Ölçü    | Kutu İçi Metraj | Fiyat |
|-----------|---------|-----------------|-------|
| AKB20-10  | 20 x 10 | 280 mt.         |       |



| Ürün Kodu | Ölçü    | Kutu İçi Metraj | Fiyat |
|-----------|---------|-----------------|-------|
| AKB25-16  | 25 x 16 | 154 mt.         |       |

# YAPIŞKANLI KABLO KANALLARI



| Ürün Kodu | Ölçü    | Kutu İçi Metraj | Fiyat |
|-----------|---------|-----------------|-------|
| AKB25-25  | 25 x 25 | 110 mt.         |       |



| Ürün Kodu | Ölçü    | Kutu İçi Metraj | Fiyat |
|-----------|---------|-----------------|-------|
| AKB40-16  | 40 x 16 | 98 mt.          |       |

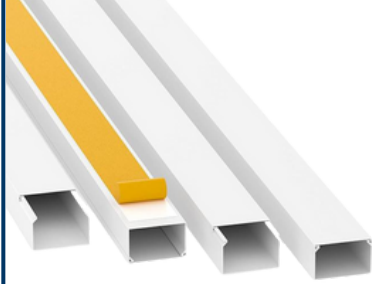

| Ürün Kodu | Ölçü    | Kutu İçi Metraj | Fiyat |
|-----------|---------|-----------------|-------|
| AKB40-25  | 40 x 25 | 70 mt.          |       |



| Ürün Kodu | Ölçü    | Kutu İçi Metraj | Fiyat |
|-----------|---------|-----------------|-------|
| AKB40-40  | 40 x 40 | 72 mt.          |       |



| Ürün Kodu | Ölçü    | Kutu İçi Metraj | Fiyat |
|-----------|---------|-----------------|-------|
| AKB60-40  | 60 x 40 | 48 mt.          |       |

# DELİKLİ KABLO KANALLARI

|    | <table><thead><tr><th>Ürün Kodu</th><th>Ölçü</th><th>Kutu İçi Metraj</th><th>Fiyat</th></tr></thead><tbody><tr><td>AKS25-25</td><td>25 x 25</td><td>100 mt.</td><td></td></tr></tbody></table> | Ürün Kodu       | Ölçü  | Kutu İçi Metraj | Fiyat | AKS25-25 | 25 x 25 | 100 mt. |  |
|--|--|-----------------|-------|-----------------|-------|----------|---------|---------|--|
| Ürün Kodu  | Ölçü   | Kutu İçi Metraj | Fiyat |                 |       |          |         |         |  |
| AKS25-25   | 25 x 25  | 100 mt.         |       |                 |       |          |         |         |  |
|    | <table><thead><tr><th>Ürün Kodu</th><th>Ölçü</th><th>Kutu İçi Metraj</th><th>Fiyat</th></tr></thead><tbody><tr><td>AKS25-40</td><td>25 x 40</td><td>80 mt.</td><td></td></tr></tbody></table>  | Ürün Kodu       | Ölçü  | Kutu İçi Metraj | Fiyat | AKS25-40 | 25 x 40 | 80 mt.  |  |
| Ürün Kodu  | Ölçü   | Kutu İçi Metraj | Fiyat |                 |       |          |         |         |  |
| AKS25-40   | 25 x 40  | 80 mt.          |       |                 |       |          |         |         |  |
|   | <table><thead><tr><th>Ürün Kodu</th><th>Ölçü</th><th>Kutu İçi Metraj</th><th>Fiyat</th></tr></thead><tbody><tr><td>AKS25-60</td><td>25 x 60</td><td>48 mt.</td><td></td></tr></tbody></table>  | Ürün Kodu       | Ölçü  | Kutu İçi Metraj | Fiyat | AKS25-60 | 25 x 60 | 48 mt.  |  |
| Ürün Kodu  | Ölçü   | Kutu İçi Metraj | Fiyat |                 |       |          |         |         |  |
| AKS25-60   | 25 x 60  | 48 mt.          |       |                 |       |          |         |         |  |
|  | <table><thead><tr><th>Ürün Kodu</th><th>Ölçü</th><th>Kutu İçi Metraj</th><th>Fiyat</th></tr></thead><tbody><tr><td>AKS40-40</td><td>40 x 40</td><td>72 mt.</td><td></td></tr></tbody></table>  | Ürün Kodu       | Ölçü  | Kutu İçi Metraj | Fiyat | AKS40-40 | 40 x 40 | 72 mt.  |  |
| Ürün Kodu  | Ölçü   | Kutu İçi Metraj | Fiyat |                 |       |          |         |         |  |
| AKS40-40   | 40 x 40  | 72 mt.          |       |                 |       |          |         |         |  |
|  | <table><thead><tr><th>Ürün Kodu</th><th>Ölçü</th><th>Kutu İçi Metraj</th><th>Fiyat</th></tr></thead><tbody><tr><td>AKS40-60</td><td>40 x 60</td><td>48 mt.</td><td></td></tr></tbody></table>  | Ürün Kodu       | Ölçü  | Kutu İçi Metraj | Fiyat | AKS40-60 | 40 x 60 | 48 mt.  |  |
| Ürün Kodu  | Ölçü   | Kutu İçi Metraj | Fiyat |                 |       |          |         |         |  |
| AKS40-60   | 40 x 60  | 48 mt.          |       |                 |       |          |         |         |  |

# DELİKLİ KABLO KANALLARI

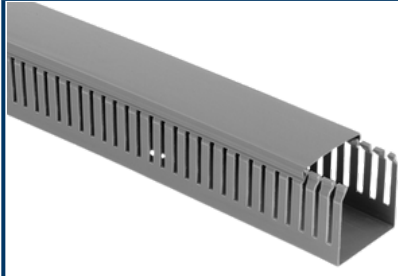

| Ürün Kodu | Ölçü    | Kutu İçi Metraj | Fiyat |
|-----------|---------|-----------------|-------|
| AKS60-60  | 60 x 60 | 32 mt.          |       |

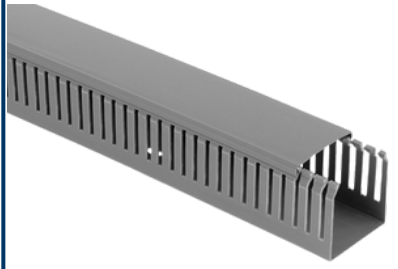

| Ürün Kodu | Ölçü    | Kutu İçi Metraj | Fiyat |
|-----------|---------|-----------------|-------|
| AKS60-80  | 60 x 80 | 24 mt.          |       |

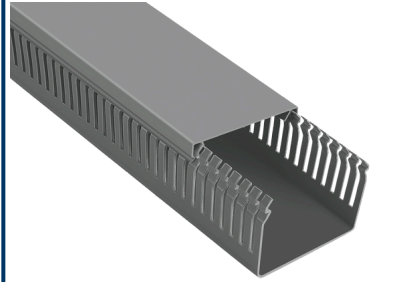

| Ürün Kodu | Ölçü    | Kutu İçi Metraj | Fiyat |
|-----------|---------|-----------------|-------|
| AKS80-60  | 80 x 60 | 24 mt.          |       |

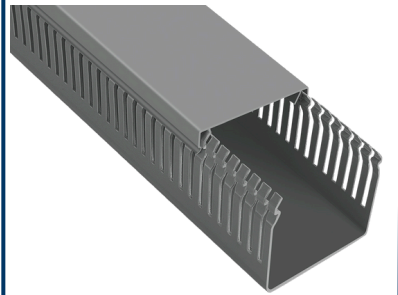

| Ürün Kodu | Ölçü    | Kutu İçi Metraj | Fiyat |
|-----------|---------|-----------------|-------|
| AKS80-80  | 80 x 80 | 18 mt.          |       |



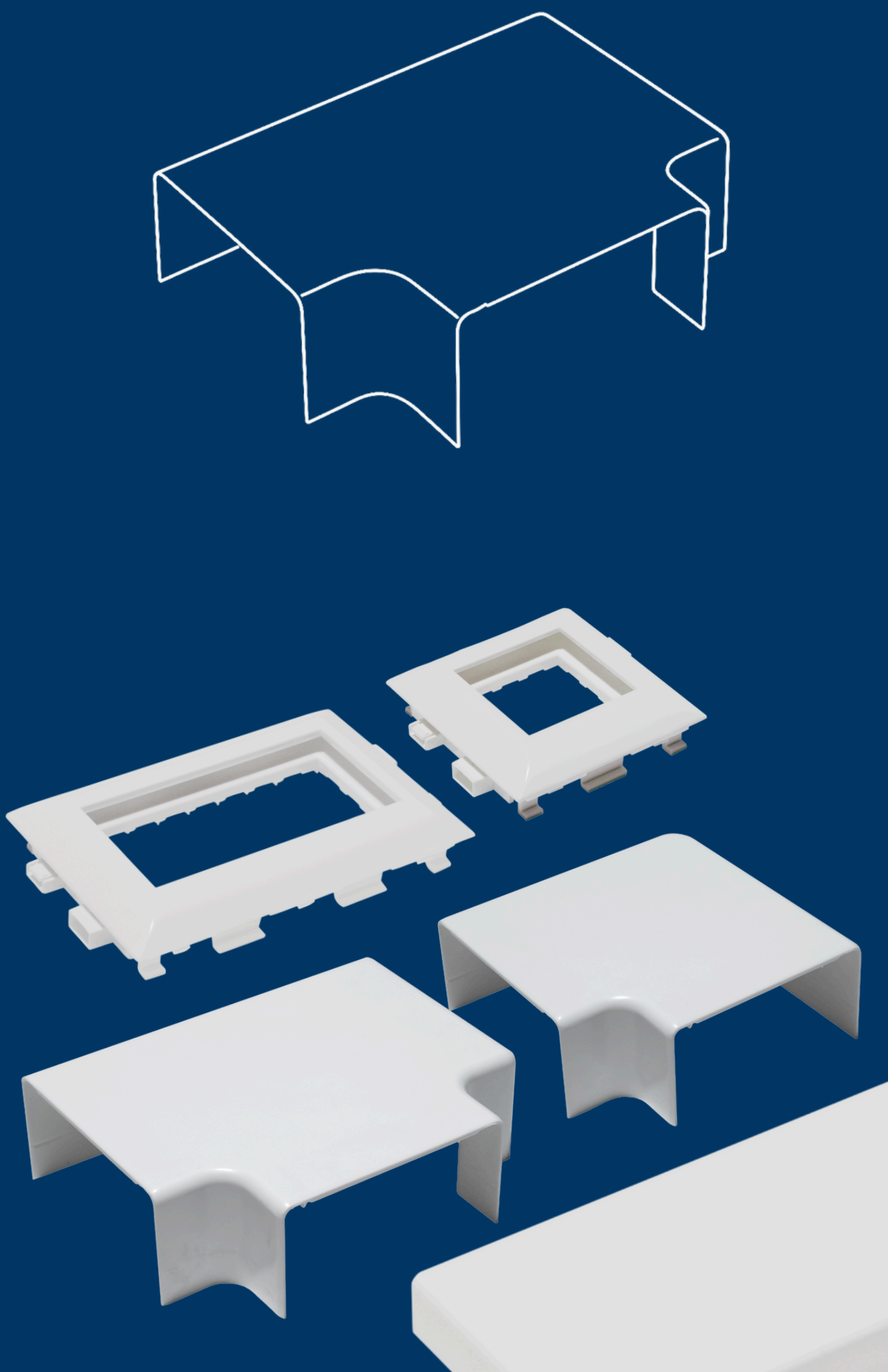

|    | <table><thead><tr><th>Ürün Kodu</th><th>Ölçü</th><th>Kutu İçi Metraj</th><th>Fiyat</th></tr></thead><tbody><tr><td>AKFT50-12</td><td>50 x 12</td><td>108 mt.</td><td></td></tr></tbody></table>  | Ürün Kodu       | Ölçü  | Kutu İçi Metraj | Fiyat | AKFT50-12  | 50 x 12 | 108 mt. |  |
|--|--|-----------------|-------|-----------------|-------|------------|---------|---------|--|
| Ürün Kodu  | Ölçü   | Kutu İçi Metraj | Fiyat |                 |       |            |         |         |  |
| AKFT50-12  | 50 x 12  | 108 mt.         |       |                 |       |            |         |         |  |
|    | <table><thead><tr><th>Ürün Kodu</th><th>Ölçü</th><th>Kutu İçi Metraj</th><th>Fiyat</th></tr></thead><tbody><tr><td>AKFTY50-12</td><td>50 x 12</td><td>108 mt.</td><td></td></tr></tbody></table> | Ürün Kodu       | Ölçü  | Kutu İçi Metraj | Fiyat | AKFTY50-12 | 50 x 12 | 108 mt. |  |
| Ürün Kodu  | Ölçü   | Kutu İçi Metraj | Fiyat |                 |       |            |         |         |  |
| AKFTY50-12   | 50 x 12  | 108 mt.         |       |                 |       |            |         |         |  |
|   | <table><thead><tr><th>Ürün Kodu</th><th>Ölçü</th><th>Kutu İçi Metraj</th><th>Fiyat</th></tr></thead><tbody><tr><td>AKFT75-20</td><td>75 x 20</td><td>56 mt.</td><td></td></tr></tbody></table>   | Ürün Kodu       | Ölçü  | Kutu İçi Metraj | Fiyat | AKFT75-20  | 75 x 20 | 56 mt.  |  |
| Ürün Kodu  | Ölçü   | Kutu İçi Metraj | Fiyat |                 |       |            |         |         |  |
| AKFT75-20  | 75 x 20  | 56 mt.          |       |                 |       |            |         |         |  |
|  | <table><thead><tr><th>Ürün Kodu</th><th>Ölçü</th><th>Kutu İçi Metraj</th><th>Fiyat</th></tr></thead><tbody><tr><td>AKFTY75-20</td><td>75 x 20</td><td>56 mt.</td><td></td></tr></tbody></table>  | Ürün Kodu       | Ölçü  | Kutu İçi Metraj | Fiyat | AKFTY75-20 | 75 x 20 | 56 mt.  |  |
| Ürün Kodu  | Ölçü   | Kutu İçi Metraj | Fiyat |                 |       |            |         |         |  |
| AKFTY75-20   | 75 x 20  | 56 mt.          |       |                 |       |            |         |         |  |
|  | <table><thead><tr><th>Ürün Kodu</th><th>Ölçü</th><th>Kutu İçi Metraj</th><th>Fiyat</th></tr></thead><tbody><tr><td>AKFT90-20</td><td>90 x 20</td><td>36 mt.</td><td></td></tr></tbody></table>   | Ürün Kodu       | Ölçü  | Kutu İçi Metraj | Fiyat | AKFT90-20  | 90 x 20 | 36 mt.  |  |
| Ürün Kodu  | Ölçü   | Kutu İçi Metraj | Fiyat |                 |       |            |         |         |  |
| AKFT90-20  | 90 x 20  | 36 mt.          |       |                 |       |            |         |         |  |
|  | <table><thead><tr><th>Ürün Kodu</th><th>Ölçü</th><th>Kutu İçi Metraj</th><th>Fiyat</th></tr></thead><tbody><tr><td>AKFTY90-20</td><td>90 x 20</td><td>36 mt.</td><td></td></tr></tbody></table>  | Ürün Kodu       | Ölçü  | Kutu İçi Metraj | Fiyat | AKFTY90-20 | 90 x 20 | 36 mt.  |  |
| Ürün Kodu  | Ölçü   | Kutu İçi Metraj | Fiyat |                 |       |            |         |         |  |
| AKFTY90-20   | 90 x 20  | 36 mt.          |       |                 |       |            |         |         |  |

# KANAL AKSEUARLARI

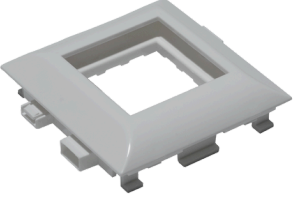
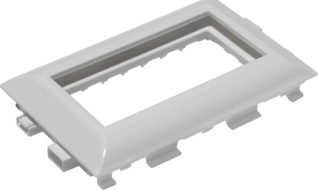

|    | <table><thead><tr><th>Ürün Kodu</th><th>Ürün</th><th>Kutu Adet</th><th>Fiyat</th></tr></thead><tbody><tr><td>154 01</td><td>İç Köşe</td><td>12 Adet</td><td></td></tr></tbody></table>      | Ürün Kodu | Ürün  | Kutu Adet | Fiyat | 154 01 | İç Köşe      | 12 Adet |  |
|---|---|-----------|-------|-----------|-------|--------|--------------|---------|--|
| Ürün Kodu   | Ürün  | Kutu Adet | Fiyat |           |       |        |              |         |  |
| 154 01  | İç Köşe   | 12 Adet   |       |           |       |        |              |         |  |
|    | <table><thead><tr><th>Ürün Kodu</th><th>Ürün</th><th>Kutu Adet</th><th>Fiyat</th></tr></thead><tbody><tr><td>153 01</td><td>Dış Köşe</td><td>10 Adet</td><td></td></tr></tbody></table>     | Ürün Kodu | Ürün  | Kutu Adet | Fiyat | 153 01 | Dış Köşe     | 10 Adet |  |
| Ürün Kodu   | Ürün  | Kutu Adet | Fiyat |           |       |        |              |         |  |
| 153 01  | Dış Köşe  | 10 Adet   |       |           |       |        |              |         |  |
|   | <table><thead><tr><th>Ürün Kodu</th><th>Ürün</th><th>Kutu Adet</th><th>Fiyat</th></tr></thead><tbody><tr><td>151 01</td><td>L Bağlantı</td><td>12 Adet</td><td></td></tr></tbody></table>   | Ürün Kodu | Ürün  | Kutu Adet | Fiyat | 151 01 | L Bağlantı   | 12 Adet |  |
| Ürün Kodu   | Ürün  | Kutu Adet | Fiyat |           |       |        |              |         |  |
| 151 01  | L Bağlantı  | 12 Adet   |       |           |       |        |              |         |  |
|  | <table><thead><tr><th>Ürün Kodu</th><th>Ürün</th><th>Kutu Adet</th><th>Fiyat</th></tr></thead><tbody><tr><td>151 02</td><td>T Bağlantı</td><td>12 Adet</td><td></td></tr></tbody></table>   | Ürün Kodu | Ürün  | Kutu Adet | Fiyat | 151 02 | T Bağlantı   | 12 Adet |  |
| Ürün Kodu   | Ürün  | Kutu Adet | Fiyat |           |       |        |              |         |  |
| 151 02  | T Bağlantı  | 12 Adet   |       |           |       |        |              |         |  |
|  | <table><thead><tr><th>Ürün Kodu</th><th>Ürün</th><th>Kutu Adet</th><th>Fiyat</th></tr></thead><tbody><tr><td>155 01</td><td>Sonlandırma</td><td>24 Adet</td><td></td></tr></tbody></table>  | Ürün Kodu | Ürün  | Kutu Adet | Fiyat | 155 01 | Sonlandırma  | 24 Adet |  |
| Ürün Kodu   | Ürün  | Kutu Adet | Fiyat |           |       |        |              |         |  |
| 155 01  | Sonlandırma   | 24 Adet   |       |           |       |        |              |         |  |
|  | <table><thead><tr><th>Ürün Kodu</th><th>Ürün</th><th>Kutu Adet</th><th>Fiyat</th></tr></thead><tbody><tr><td>156 01</td><td>Ara Bağlantı</td><td>24 Adet</td><td></td></tr></tbody></table> | Ürün Kodu | Ürün  | Kutu Adet | Fiyat | 156 01 | Ara Bağlantı | 24 Adet |  |
| Ürün Kodu   | Ürün  | Kutu Adet | Fiyat |           |       |        |              |         |  |
| 156 01  | Ara Bağlantı  | 24 Adet   |       |           |       |        |              |         |  |

|    | <table><thead><tr><th>Ürün Kodu</th><th>Ürün</th><th>Kutu Adet</th><th>Fiyat</th></tr></thead><tbody><tr><td>150 01</td><td>Priz Montaj Kasası<br/>80*80</td><td>24 Adet</td><td></td></tr></tbody></table> | Ürün Kodu | Ürün  | Kutu Adet | Fiyat | 150 01 | Priz Montaj Kasası<br>80*80 | 24 Adet |  |
|---|---|-----------|-------|-----------|-------|--------|-----------------------------|---------|--|
| Ürün Kodu   | Ürün  | Kutu Adet | Fiyat |           |       |        |                             |         |  |
| 150 01  | Priz Montaj Kasası<br>80*80   | 24 Adet   |       |           |       |        |                             |         |  |
|    | <table><thead><tr><th>Ürün Kodu</th><th>Ürün</th><th>Kutu Adet</th><th>Fiyat</th></tr></thead><tbody><tr><td>152 01</td><td>Tekli Çerçeve<br/>45*45</td><td>12 Adet</td><td></td></tr></tbody></table>      | Ürün Kodu | Ürün  | Kutu Adet | Fiyat | 152 01 | Tekli Çerçeve<br>45*45      | 12 Adet |  |
| Ürün Kodu   | Ürün  | Kutu Adet | Fiyat |           |       |        |                             |         |  |
| 152 01  | Tekli Çerçeve<br>45*45  | 12 Adet   |       |           |       |        |                             |         |  |
|  | <table><thead><tr><th>Ürün Kodu</th><th>Ürün</th><th>Kutu Adet</th><th>Fiyat</th></tr></thead><tbody><tr><td>157 02</td><td>İkili Çerçeve<br/>45*45</td><td>12 Adet</td><td></td></tr></tbody></table>      | Ürün Kodu | Ürün  | Kutu Adet | Fiyat | 157 02 | İkili Çerçeve<br>45*45      | 12 Adet |  |
| Ürün Kodu   | Ürün  | Kutu Adet | Fiyat |           |       |        |                             |         |  |
| 157 02  | İkili Çerçeve<br>45*45  | 12 Adet   |       |           |       |        |                             |         |  |
|  | <table><thead><tr><th>Ürün Kodu</th><th>Ürün</th><th>Kutu Adet</th><th>Fiyat</th></tr></thead><tbody><tr><td>158 03</td><td>Üçlü Çerçeve<br/>45*45</td><td>12 Adet</td><td></td></tr></tbody></table>       | Ürün Kodu | Ürün  | Kutu Adet | Fiyat | 158 03 | Üçlü Çerçeve<br>45*45       | 12 Adet |  |
| Ürün Kodu   | Ürün  | Kutu Adet | Fiyat |           |       |        |                             |         |  |
| 158 03  | Üçlü Çerçeve<br>45*45   | 12 Adet   |       |           |       |        |                             |         |  |
|   | <table><thead><tr><th>Ürün Kodu</th><th>Ürün</th><th>Kutu Adet</th><th>Fiyat</th></tr></thead><tbody><tr><td>160 04</td><td>Dörtlü Çerçeve<br/>45*45</td><td>20 Adet</td><td></td></tr></tbody></table>     | Ürün Kodu | Ürün  | Kutu Adet | Fiyat | 160 04 | Dörtlü Çerçeve<br>45*45     | 20 Adet |  |
| Ürün Kodu   | Ürün  | Kutu Adet | Fiyat |           |       |        |                             |         |  |
| 160 04  | Dörtlü Çerçeve<br>45*45   | 20 Adet   |       |           |       |        |                             |         |  |

# SIGORTA KUTULLARI

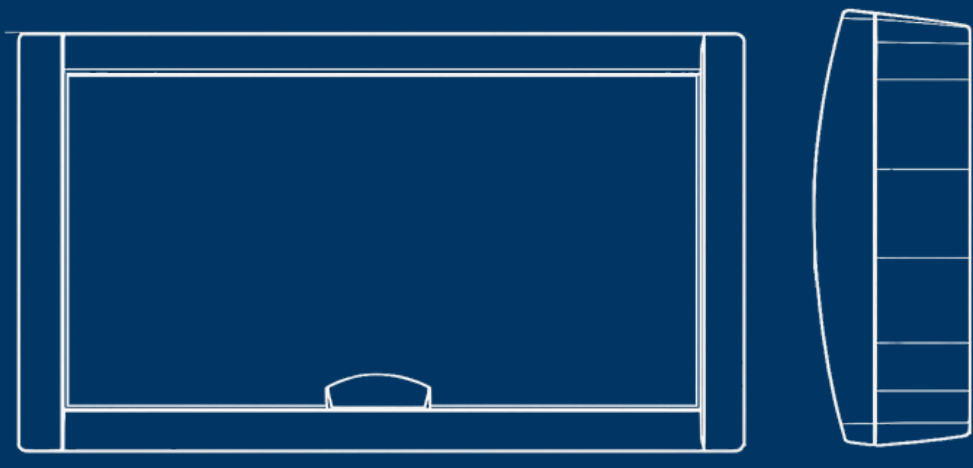

# SIVA ALTI SİGORTA KUTULARI

|    | <table><thead><tr><th>Ürün Kodu</th><th>Modül Sayısı</th><th>En mm</th><th>Boy mm</th><th>Derinlik mm</th><th>Fiyat</th></tr></thead><tbody><tr><td>SA87</td><td>6'lı Sıva Altı</td><td></td><td></td><td></td><td></td></tr></tbody></table>  | Ürün Kodu | Modül Sayısı | En mm       | Boy mm | Derinlik mm | Fiyat | SA87 | 6'lı Sıva Altı  |  |  |  |  |
|---|--|-----------|--------------|-------------|--------|-------------|-------|------|-----------------|--|--|--|--|
| Ürün Kodu   | Modül Sayısı   | En mm     | Boy mm       | Derinlik mm | Fiyat  |             |       |      |                 |  |  |  |  |
| SA87  | 6'lı Sıva Altı   |           |              |             |        |             |       |      |                 |  |  |  |  |
|    | <table><thead><tr><th>Ürün Kodu</th><th>Modül Sayısı</th><th>En mm</th><th>Boy mm</th><th>Derinlik mm</th><th>Fiyat</th></tr></thead><tbody><tr><td>SA89</td><td>9'lu Sıva Altı</td><td></td><td></td><td></td><td></td></tr></tbody></table>  | Ürün Kodu | Modül Sayısı | En mm       | Boy mm | Derinlik mm | Fiyat | SA89 | 9'lu Sıva Altı  |  |  |  |  |
| Ürün Kodu   | Modül Sayısı   | En mm     | Boy mm       | Derinlik mm | Fiyat  |             |       |      |                 |  |  |  |  |
| SA89  | 9'lu Sıva Altı   |           |              |             |        |             |       |      |                 |  |  |  |  |
|   | <table><thead><tr><th>Ürün Kodu</th><th>Modül Sayısı</th><th>En mm</th><th>Boy mm</th><th>Derinlik mm</th><th>Fiyat</th></tr></thead><tbody><tr><td>SA91</td><td>12'li Sıva Altı</td><td></td><td></td><td></td><td></td></tr></tbody></table> | Ürün Kodu | Modül Sayısı | En mm       | Boy mm | Derinlik mm | Fiyat | SA91 | 12'li Sıva Altı |  |  |  |  |
| Ürün Kodu   | Modül Sayısı   | En mm     | Boy mm       | Derinlik mm | Fiyat  |             |       |      |                 |  |  |  |  |
| SA91  | 12'li Sıva Altı  |           |              |             |        |             |       |      |                 |  |  |  |  |
|  | <table><thead><tr><th>Ürün Kodu</th><th>Modül Sayısı</th><th>En mm</th><th>Boy mm</th><th>Derinlik mm</th><th>Fiyat</th></tr></thead><tbody><tr><td>SA93</td><td>16'lı Sıva Altı</td><td></td><td></td><td></td><td></td></tr></tbody></table> | Ürün Kodu | Modül Sayısı | En mm       | Boy mm | Derinlik mm | Fiyat | SA93 | 16'lı Sıva Altı |  |  |  |  |
| Ürün Kodu   | Modül Sayısı   | En mm     | Boy mm       | Derinlik mm | Fiyat  |             |       |      |                 |  |  |  |  |
| SA93  | 16'lı Sıva Altı  |           |              |             |        |             |       |      |                 |  |  |  |  |
|  | <table><thead><tr><th>Ürün Kodu</th><th>Modül Sayısı</th><th>En mm</th><th>Boy mm</th><th>Derinlik mm</th><th>Fiyat</th></tr></thead><tbody><tr><td>SA95</td><td>24'lü Sıva Altı</td><td></td><td></td><td></td><td></td></tr></tbody></table> | Ürün Kodu | Modül Sayısı | En mm       | Boy mm | Derinlik mm | Fiyat | SA95 | 24'lü Sıva Altı |  |  |  |  |
| Ürün Kodu   | Modül Sayısı   | En mm     | Boy mm       | Derinlik mm | Fiyat  |             |       |      |                 |  |  |  |  |
| SA95  | 24'lü Sıva Altı  |           |              |             |        |             |       |      |                 |  |  |  |  |
|  | <table><thead><tr><th>Ürün Kodu</th><th>Modül Sayısı</th><th>En mm</th><th>Boy mm</th><th>Derinlik mm</th><th>Fiyat</th></tr></thead><tbody><tr><td>SA97</td><td>36'lı Sıva Altı</td><td></td><td></td><td></td><td></td></tr></tbody></table> | Ürün Kodu | Modül Sayısı | En mm       | Boy mm | Derinlik mm | Fiyat | SA97 | 36'lı Sıva Altı |  |  |  |  |
| Ürün Kodu   | Modül Sayısı   | En mm     | Boy mm       | Derinlik mm | Fiyat  |             |       |      |                 |  |  |  |  |
| SA97  | 36'lı Sıva Altı  |           |              |             |        |             |       |      |                 |  |  |  |  |

|    | <table border="1"><thead><tr><th>Ürün Kodu</th><th>Modül Sayısı</th><th>En mm</th><th>Boy mm</th><th>Derinlik mm</th><th>Fiyat</th></tr></thead><tbody><tr><td>SU86</td><td>6'lı Siva Üstü</td><td></td><td></td><td></td><td></td></tr></tbody></table>  | Ürün Kodu | Modül Sayısı | En mm       | Boy mm | Derinlik mm | Fiyat | SU86 | 6'lı Siva Üstü  |  |  |  |  |
|---|---|-----------|--------------|-------------|--------|-------------|-------|------|-----------------|--|--|--|--|
| Ürün Kodu   | Modül Sayısı  | En mm     | Boy mm       | Derinlik mm | Fiyat  |             |       |      |                 |  |  |  |  |
| SU86  | 6'lı Siva Üstü  |           |              |             |        |             |       |      |                 |  |  |  |  |
|    | <table border="1"><thead><tr><th>Ürün Kodu</th><th>Modül Sayısı</th><th>En mm</th><th>Boy mm</th><th>Derinlik mm</th><th>Fiyat</th></tr></thead><tbody><tr><td>SU88</td><td>9'lu Siva Üstü</td><td></td><td></td><td></td><td></td></tr></tbody></table>  | Ürün Kodu | Modül Sayısı | En mm       | Boy mm | Derinlik mm | Fiyat | SU88 | 9'lu Siva Üstü  |  |  |  |  |
| Ürün Kodu   | Modül Sayısı  | En mm     | Boy mm       | Derinlik mm | Fiyat  |             |       |      |                 |  |  |  |  |
| SU88  | 9'lu Siva Üstü  |           |              |             |        |             |       |      |                 |  |  |  |  |
|   | <table border="1"><thead><tr><th>Ürün Kodu</th><th>Modül Sayısı</th><th>En mm</th><th>Boy mm</th><th>Derinlik mm</th><th>Fiyat</th></tr></thead><tbody><tr><td>SU90</td><td>12'li Siva Üstü</td><td></td><td></td><td></td><td></td></tr></tbody></table> | Ürün Kodu | Modül Sayısı | En mm       | Boy mm | Derinlik mm | Fiyat | SU90 | 12'li Siva Üstü |  |  |  |  |
| Ürün Kodu   | Modül Sayısı  | En mm     | Boy mm       | Derinlik mm | Fiyat  |             |       |      |                 |  |  |  |  |
| SU90  | 12'li Siva Üstü   |           |              |             |        |             |       |      |                 |  |  |  |  |
|  | <table border="1"><thead><tr><th>Ürün Kodu</th><th>Modül Sayısı</th><th>En mm</th><th>Boy mm</th><th>Derinlik mm</th><th>Fiyat</th></tr></thead><tbody><tr><td>SU92</td><td>16'lı Siva Üstü</td><td></td><td></td><td></td><td></td></tr></tbody></table> | Ürün Kodu | Modül Sayısı | En mm       | Boy mm | Derinlik mm | Fiyat | SU92 | 16'lı Siva Üstü |  |  |  |  |
| Ürün Kodu   | Modül Sayısı  | En mm     | Boy mm       | Derinlik mm | Fiyat  |             |       |      |                 |  |  |  |  |
| SU92  | 16'lı Siva Üstü   |           |              |             |        |             |       |      |                 |  |  |  |  |
|  | <table border="1"><thead><tr><th>Ürün Kodu</th><th>Modül Sayısı</th><th>En mm</th><th>Boy mm</th><th>Derinlik mm</th><th>Fiyat</th></tr></thead><tbody><tr><td>SU94</td><td>24'lü Siva Üstü</td><td></td><td></td><td></td><td></td></tr></tbody></table> | Ürün Kodu | Modül Sayısı | En mm       | Boy mm | Derinlik mm | Fiyat | SU94 | 24'lü Siva Üstü |  |  |  |  |
| Ürün Kodu   | Modül Sayısı  | En mm     | Boy mm       | Derinlik mm | Fiyat  |             |       |      |                 |  |  |  |  |
| SU94  | 24'lü Siva Üstü   |           |              |             |        |             |       |      |                 |  |  |  |  |
|  | <table border="1"><thead><tr><th>Ürün Kodu</th><th>Modül Sayısı</th><th>En mm</th><th>Boy mm</th><th>Derinlik mm</th><th>Fiyat</th></tr></thead><tbody><tr><td>SU96</td><td>36'lı Siva Üstü</td><td></td><td></td><td></td><td></td></tr></tbody></table> | Ürün Kodu | Modül Sayısı | En mm       | Boy mm | Derinlik mm | Fiyat | SU96 | 36'lı Siva Üstü |  |  |  |  |
| Ürün Kodu   | Modül Sayısı  | En mm     | Boy mm       | Derinlik mm | Fiyat  |             |       |      |                 |  |  |  |  |
| SU96  | 36'lı Siva Üstü   |           |              |             |        |             |       |      |                 |  |  |  |  |

# KAUÇUK PRİZLER

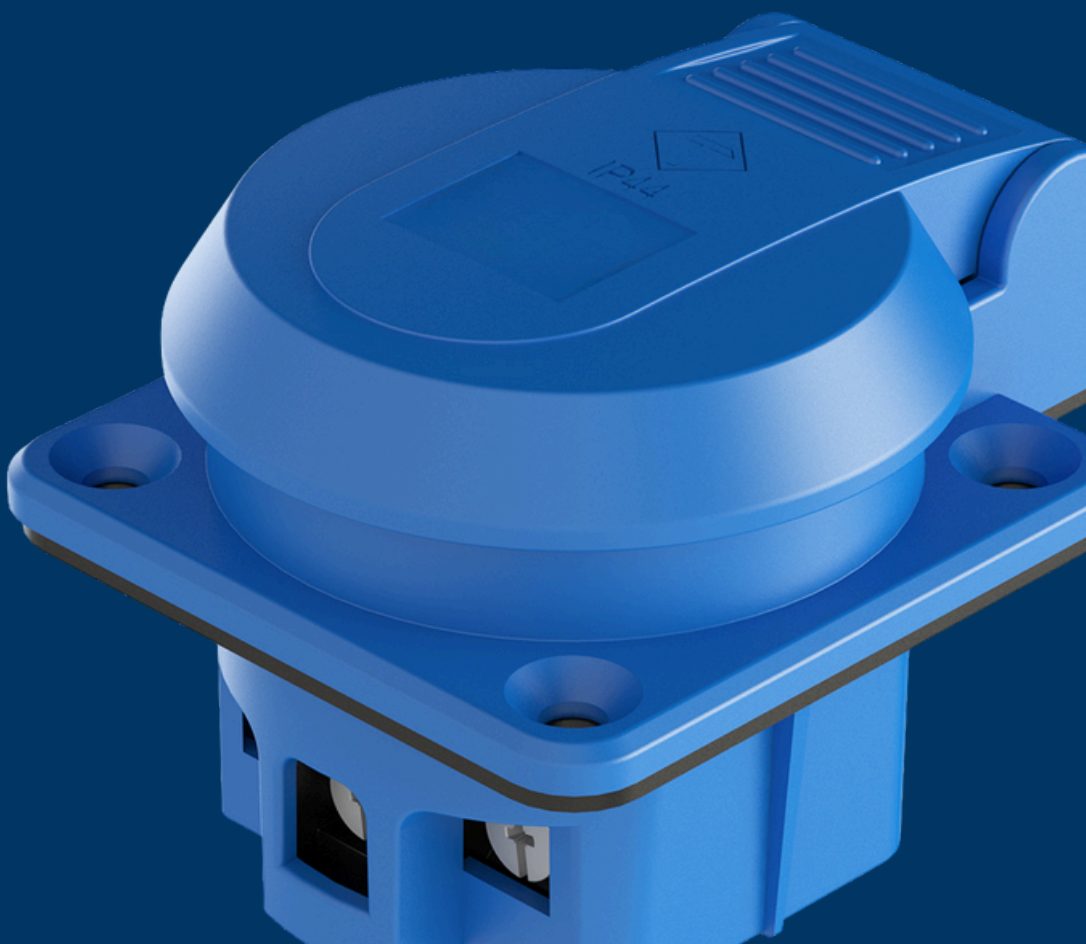





| Ürün        | Ürün Kodu | Kutu Adet | Koli Adet | Fiyat |
|-------------|-----------|-----------|-----------|-------|
| Duvar Prizi | 1KMP-F    | 30 Adet   | 180 Adet  |       |



| Ürün           | Ürün Kodu | Kutu Adet | Koli Adet | Fiyat |
|----------------|-----------|-----------|-----------|-------|
| 2'li Grup Priz | 2KMP-F    | 18 Adet   | 108 Adet  |       |



| Ürün           | Ürün Kodu | Kutu Adet | Koli Adet | Fiyat |
|----------------|-----------|-----------|-----------|-------|
| 3'lü Grup Priz | 3 KMP-f   | 14 Adet   | 84 Adet   |       |



| Ürün           | Ürün Kodu | Kutu Adet | Koli Adet | Fiyat |
|----------------|-----------|-----------|-----------|-------|
| 4'lü Grup Priz | 4KMP-F    | 10 Adet   | 60 Adet   |       |



| Ürün            | Ürün Kodu | Kutu Adet | Koli Adet | Fiyat |
|-----------------|-----------|-----------|-----------|-------|
| Tekli Grup Priz | 1KTP      | 20 Adet   | 120 Adet  |       |



| Ürün           | Ürün Kodu | Kutu Adet | Koli Adet | Fiyat |
|----------------|-----------|-----------|-----------|-------|
| 2'li Grup Priz | 2KTP      | 12 Adet   | 72 Adet   |       |



| Ürün           | Ürün Kodu | Kutu Adet | Koli Adet | Fiyat |
|----------------|-----------|-----------|-----------|-------|
| 3'lü Grup Priz | 3KTP      | 8 Adet    | 48 Adet   |       |



| Ürün                                 | Ürün Kodu | Kutu Adet | Koli Adet | Fiyat |
|--------------------------------------|-----------|-----------|-----------|-------|
| 1 Trifaze<br>2 Monofaze<br>3'lü Priz | 1T2M      | 8 Adet    | 48 Adet   |       |
| 2 Trifaze<br>1 Monofaze<br>3'lü Priz | 2T1M      | 8 Adet    | 48 Adet   |       |



| Ürün       | Ürün Kodu | Kutu Adet | Koli Adet | Fiyat |
|------------|-----------|-----------|-----------|-------|
| Pano Prizi | IPS-F     | 30 Adet   | 300 Adet  |       |



| Ürün                   | Ürün Kodu | Kutu Adet | Koli Adet | Fiyat |
|------------------------|-----------|-----------|-----------|-------|
| Ray Tipi<br>Pano Prizi | RTUPS     | 10Adet    | 200 Adet  |       |



| Ürün                     | Ürün Kodu | Kutu Adet | Koli Adet | Fiyat |
|--------------------------|-----------|-----------|-----------|-------|
| Monofaze<br>Uzatma Prizi | KDP-F     | 40 Adet   | 240 Adet  |       |



| Ürün                    | Ürün Kodu | Kutu Adet | Koli Adet | Fiyat |
|-------------------------|-----------|-----------|-----------|-------|
| Trifaze<br>Uzatma Prizi | KDPT      | 25 Adet   | 150 Adet  |       |



| Model   | Ürün Kodu | Kutu Adet | Koli Adet | Fiyat |
|---------|-----------|-----------|-----------|-------|
| Düz Fiş | KEF-F     | 25 Adet   | 150 Adet  |       |



| Model      | Ürün Kodu | Kutu Adet | Koli Adet | Fiyat |
|------------|-----------|-----------|-----------|-------|
| Kulplu Fiş | KEFLK-F   | 25 Adet   | 150 Adet  |       |

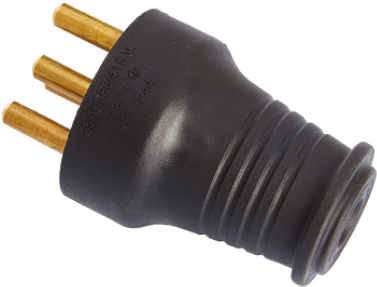

| Model                | Ürün Kodu | Kutu Adet | Koli Adet | Fiyat |
|----------------------|-----------|-----------|-----------|-------|
| Trifaze Uzatma Prizi | KDPT      | 25 Adet   | 150 Adet  |       |

# METAL & PLASTIK KABLO MAKARALARI





| Ürün                     | Ürün Kodu  | Ürün Tanıtımı                       | Fiyat |
|--------------------------|------------|-------------------------------------|-------|
| Boş Makara<br>(Kablosuz) | PMK-1000-F | Plastik Makara<br>50 mt. Kapasiteli |       |



| Ürün                       | Ürün Kodu   | Ürün Tanıtımı                                  | Fiyat |
|----------------------------|-------------|--|-------|
| Plastik Makara<br>20 Metre | PMK-20315-F | Plastik Makara<br><b>3x1,5 mm</b><br>TTR Kablo |       |
| Plastik Makara<br>35 Metre | PMK-35315-F | Plastik Makara<br><b>3x1,5 mm</b><br>TTR Kablo |       |
| Plastik Makara<br>50 Metre | PMK-50315-F | Plastik Makara<br><b>3x1,5 mm</b><br>TTR Kablo |       |
| Plastik Makara<br>20 Metre | PMK-20325-F | Plastik Makara<br><b>3x2,5 mm</b><br>TTR Kablo |       |
| Plastik Makara<br>30 Metre | PMK-30325-F | Plastik Makara<br><b>3x2,5 mm</b><br>TTR Kablo |       |
| Plastik Makara<br>40 Metre | PMK-40325-F | Plastik Makara<br><b>3x2,5 mm</b><br>TTR Kablo |       |
| Plastik Makara<br>50 Metre | PMK-50325-F | Plastik Makara<br><b>3x2,5 mm</b><br>TTR Kablo |       |

## METAL KABLO MAKARALARI



| Ürün                           | Ürün Kodu  | Ürün Tanıtımı                     | Fiyat |
|--------------------------------|------------|-----------------------------------|-------|
| Metal Boş Makara<br>(Kablosuz) | MMP-1000-F | Metal Makara<br>50 mt. Kapasiteli |       |



| Ürün                     | Ürün Kodu   | Ürün Tanıtımı  | Fiyat |
|--------------------------|-------------|--|-------|
| Metal Makara<br>20 Metre | MMP-20315-F | Metal Makara<br><b>3x1,5 mm</b><br>TTR Kablo Kapaklı |       |
| Metal Makara<br>35 Metre | MMP-35315-F | Metal Makara<br><b>3x1,5 mm</b><br>TTR Kablo Kapaklı |       |
| Metal Makara<br>50 Metre | MMP-50315-F | Metal Makara<br><b>3x1,5 mm</b><br>TTR Kablo Kapaklı |       |
| Metal Makara<br>20 Metre | MMP-20325-F | Metal Makara<br><b>3x2,5 mm</b><br>TTR Kablo Kapaklı |       |
| Metal Makara<br>30 Metre | MMP-30325-F | Metal Makara<br><b>3x2,5 mm</b><br>TTR Kablo Kapaklı |       |
| Metal Makara<br>40 Metre | MMP-40325-F | Metal Makara<br><b>3x2,5 mm</b><br>TTR Kablo Kapaklı |       |
| Metal Makara<br>50 Metre | MMP-50325-F | Metal Makara<br><b>3x2,5 mm</b><br>TTR Kablo Kapaklı |       |

# SPIRAL BORULAR

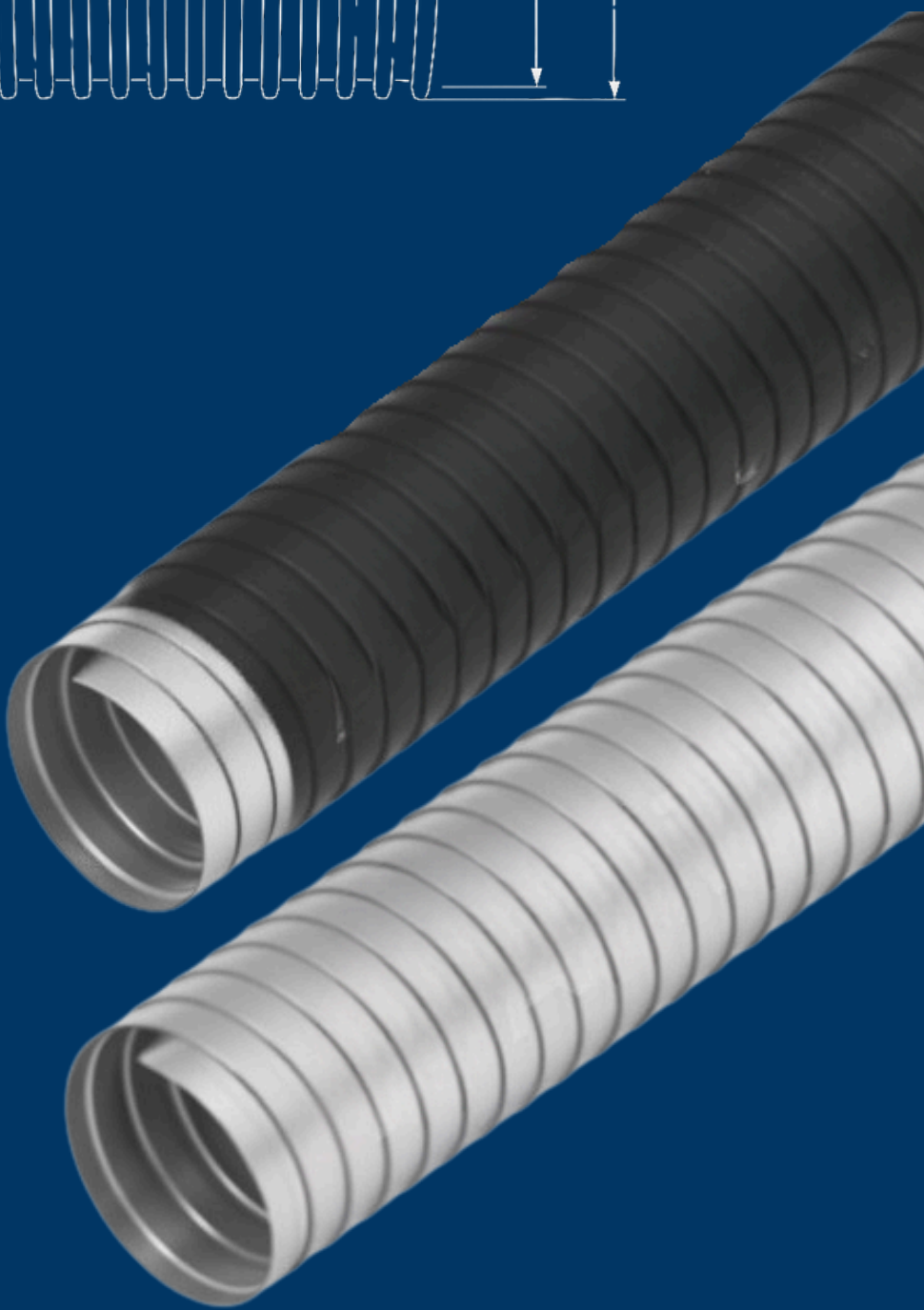
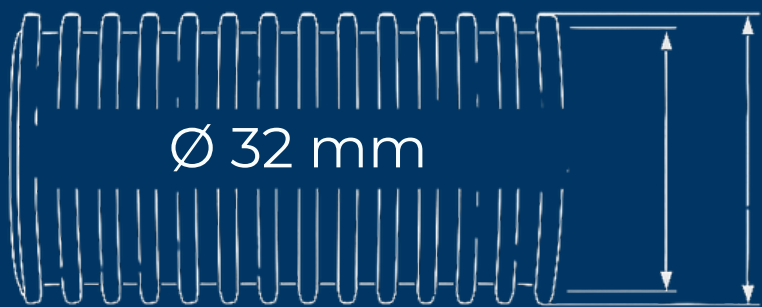
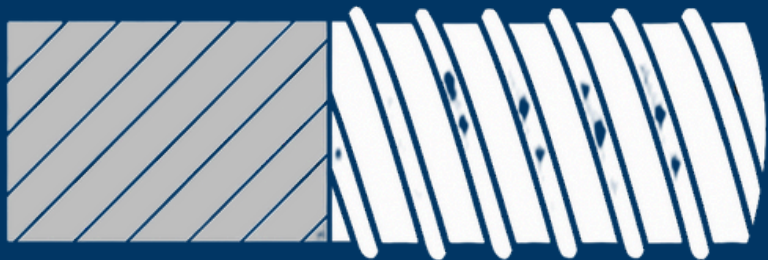





| Ürün Name    | Ölçü  | Metraj | Fiyat |
|--------------|-------|--------|-------|
| Çelik Spiral | 9 mm  | 50 mt. |       |
| Çelik Spiral | 11 mm | 50 mt. |       |
| Çelik Spiral | 14 mm | 50 mt. |       |
| Çelik Spiral | 16 mm | 50 mt. |       |
| Çelik Spiral | 18 mm | 50 mt. |       |
| Çelik Spiral | 21 mm | 50 mt. |       |
| Çelik Spiral | 26 mm | 25 mt. |       |
| Çelik Spiral | 29 mm | 25 mt. |       |
| Çelik Spiral | 32 mm | 25 mt. |       |
| Çelik Spiral | 35 mm | 25 mt. |       |
| Çelik Spiral | 37 mm | 25 mt. |       |
| Çelik Spiral | 40 mm | 25 mt. |       |
| Çelik Spiral | 42 mm | 25 mt. |       |
| Çelik Spiral | 45 mm | 25 mt. |       |
| Çelik Spiral | 50 mm | 25 mt. |       |

# PVC İZOLELİ ÇELİK SİRİRAL



| Ürün Name                | Ölçü  | Metraj | Fiyat |
|--------------------------|-------|--------|-------|
| Pvc İzoleli Çelik Spiral | 9 mm  | 50 mt. |       |
| Pvc İzoleli Çelik Spiral | 11 mm | 50 mt. |       |
| Pvc İzoleli Çelik Spiral | 14 mm | 50 mt. |       |
| Pvc İzoleli Çelik Spiral | 16 mm | 50 mt. |       |
| Pvc İzoleli Çelik Spiral | 18 mm | 50 mt. |       |
| Pvc İzoleli Çelik Spiral | 21 mm | 50 mt. |       |
| Pvc İzoleli Çelik Spiral | 26 mm | 25 mt. |       |
| Pvc İzoleli Çelik Spiral | 29 mm | 25 mt. |       |
| Pvc İzoleli Çelik Spiral | 32 mm | 25 mt. |       |
| Pvc İzoleli Çelik Spiral | 35 mm | 25 mt. |       |
| Pvc İzoleli Çelik Spiral | 37 mm | 25 mt. |       |
| Pvc İzoleli Çelik Spiral | 40 mm | 25 mt. |       |
| Pvc İzoleli Çelik Spiral | 42 mm | 25 mt. |       |
| Pvc İzoleli Çelik Spiral | 45 mm | 25 mt. |       |
| Pvc İzoleli Çelik Spiral | 50 mm | 25 mt. |       |

# KLAVUZ TELLİ İZOLELİ ÇELİK SİRAL



| Ürün Name                         | Ölçü  | Metraj | Fiyat |
|-----------------------------------|-------|--------|-------|
| Klavuz Telli İzoleli Çelik Spiral | 9 mm  | 50 mt. |       |
| Klavuz Telli İzoleli Çelik Spiral | 11 mm | 50 mt. |       |
| Klavuz Telli İzoleli Çelik Spiral | 14 mm | 50 mt. |       |
| Klavuz Telli İzoleli Çelik Spiral | 16 mm | 50 mt. |       |
| Klavuz Telli İzoleli Çelik Spiral | 18 mm | 50 mt. |       |
| Klavuz Telli İzoleli Çelik Spiral | 21 mm | 50 mt. |       |
| Klavuz Telli İzoleli Çelik Spiral | 26 mm | 25 mt. |       |
| Klavuz Telli İzoleli Çelik Spiral | 29 mm | 25 mt. |       |
| Klavuz Telli İzoleli Çelik Spiral | 32 mm | 25 mt. |       |
| Klavuz Telli İzoleli Çelik Spiral | 35 mm | 25 mt. |       |
| Klavuz Telli İzoleli Çelik Spiral | 37 mm | 25 mt. |       |
| Klavuz Telli İzoleli Çelik Spiral | 40 mm | 25 mt. |       |
| Klavuz Telli İzoleli Çelik Spiral | 42 mm | 25 mt. |       |
| Klavuz Telli İzoleli Çelik Spiral | 45 mm | 25 mt. |       |
| Klavuz Telli İzoleli Çelik Spiral | 50 mm | 25 mt. |       |



# ASPIRATÖRLER

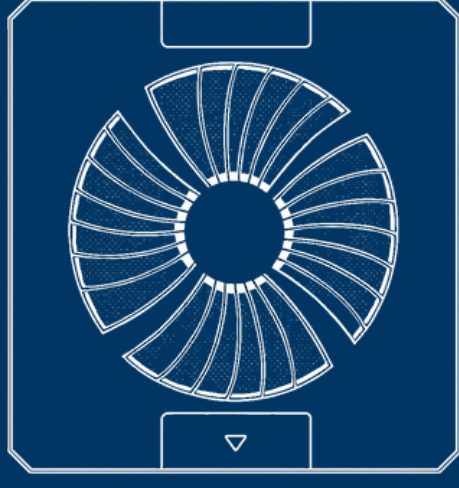
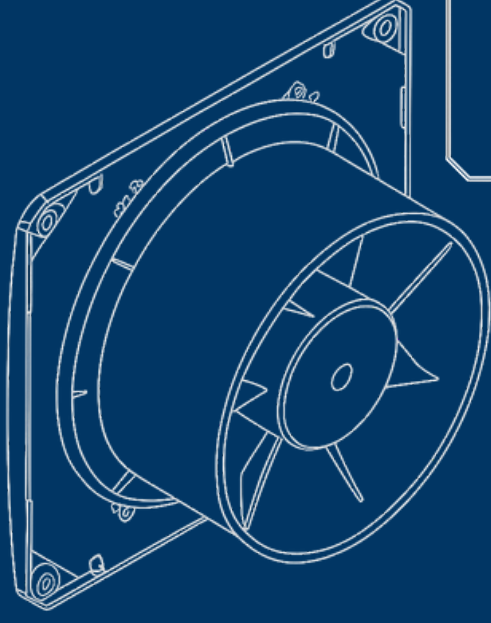



| Ürün Kodu | Devrim Hızı | Güç  | Fiyat |
|-----------|-------------|------|-------|
| ASP100    | 2250 Rpm    | 12 W |       |



| Ürün Kodu | Devrim Hızı | Güç  | Fiyat |
|-----------|-------------|------|-------|
| ASP120    | 1900 Rpm    | 15 W |       |



| Ürün Kodu | Devrim Hızı | Güç  | Fiyat |
|-----------|-------------|------|-------|
| ASP150    | 1800 Rpm    | 20 W |       |

# KLEMENSLEER

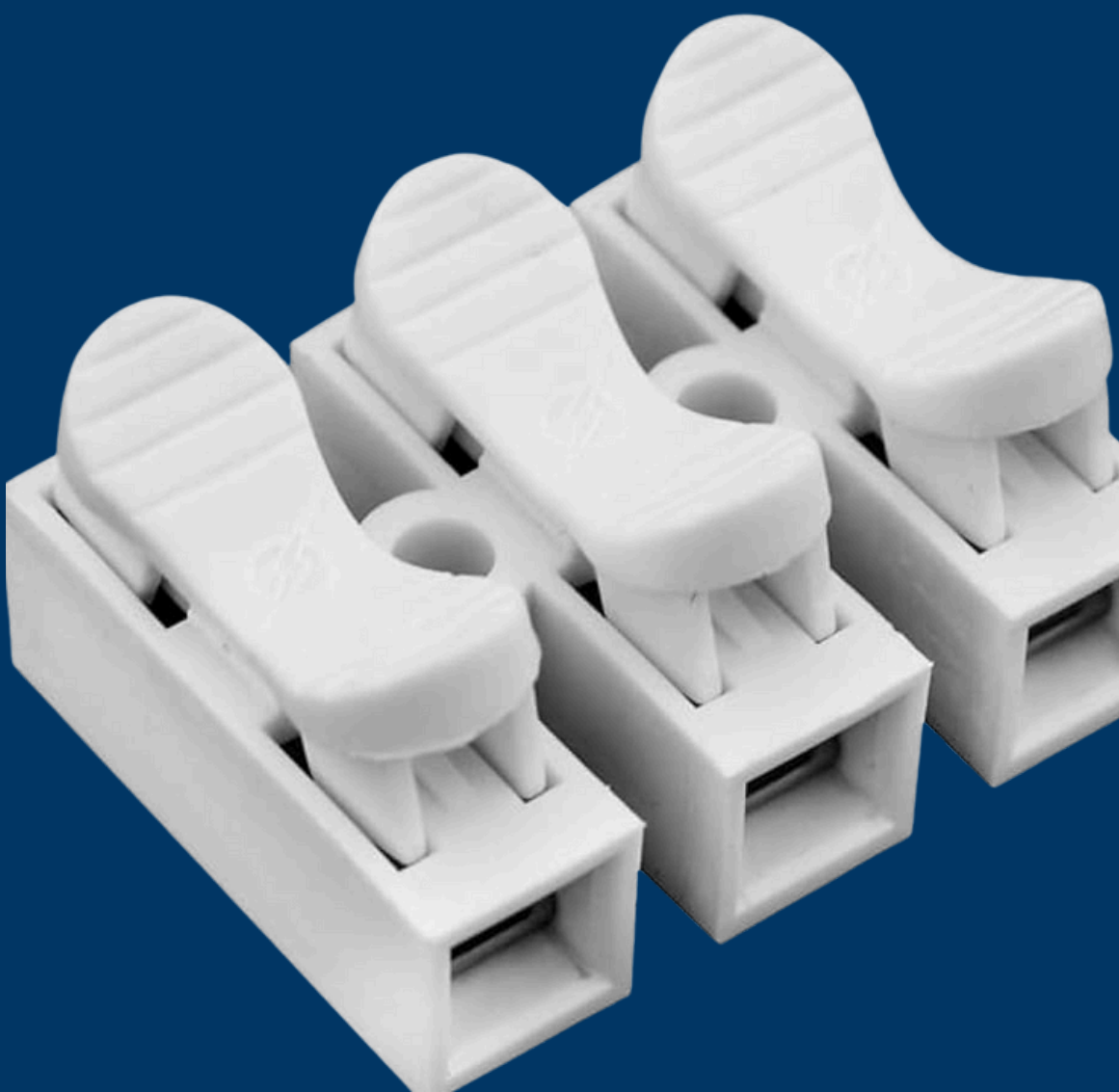
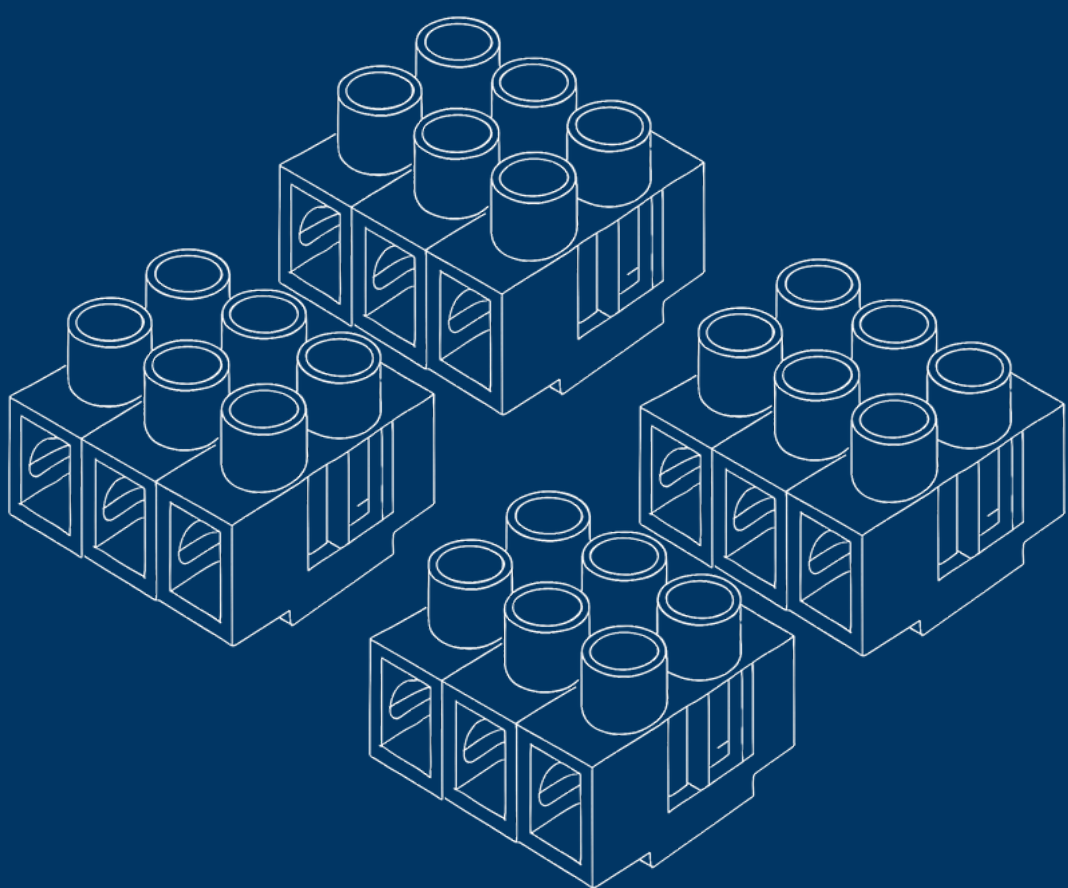





| Ürün Kodu | Ürün                    | Kutu Adet | Fiyat |
|-----------|-------------------------|-----------|-------|
| PA20 NO:1 | Isiya Dayanıklı Klemens | 50 Adet   |       |
| PA30 NO:2 | Isiya Dayanıklı Klemens | 50 Adet   |       |
| PA40 NO:3 | Isiya Dayanıklı Klemens | 50 Adet   |       |
| PA50 NO:4 | Isiya Dayanıklı Klemens | 50 Adet   |       |
| PA60 NO:5 | Isiya Dayanıklı Klemens | 50 Adet   |       |



| Ürün Kodu | Ürün                      | Kutu Adet | Fiyat |
|-----------|---------------------------|-----------|-------|
| ACK2002   | 2'li Aç-Kapa Buat Klemens | 100 Adet  |       |
| ACK2003   | 3'lü Aç-Kapa Buat Klemens | 100 Adet  |       |
| ACK2004   | 4'lü Aç-Kapa Buat Klemens | 100 Adet  |       |
| ACK2005   | 5'li Aç-Kapa Buat Klemens | 100 Adet  |       |



| Ürün Kodu | Ürün                      | Kutu Adet | Fiyat |
|-----------|---------------------------|-----------|-------|
| GBK252    | 2'li Geçmeli Buat Klemens | 100 Adet  |       |
| GBK253    | 3'lü Geçmeli Buat Klemens | 100 Adet  |       |
| GBK254    | 4'lü Geçmeli Buat Klemens | 100 Adet  |       |
| GBK255    | 5'li Geçmeli Buat Klemens | 100 Adet  |       |
| GBK256    | 6'lı Geçmeli Buat Klemens | 100 Adet  |       |
| GBK258    | 8'li Geçmeli Buat Klemens | 100 Adet  |       |

|   |                  |                                       |                  |              |
|---|------------------|---------------------------------------|------------------|--------------|
|  | <b>Ürün Kodu</b> | <b>Ürün</b>                           | <b>Kutu Adet</b> | <b>Fiyat</b> |
|   | PCT221           | 1'li<br>2 Taraflı Tırnaklı<br>Klemens | 100 Adet         |              |
|   | PCT222           | 2'li<br>2 Taraflı Tırnaklı<br>Klemens | 100 Adet         |              |
|   | PCT223           | 3'lü<br>2 Taraflı Tırnaklı<br>Klemens | 100 Adet         |              |
|  | <b>Ürün Kodu</b> | <b>Ürün</b>                           | <b>Kutu Adet</b> | <b>Fiyat</b> |
|   | BSK02            | 2'li<br>Basmalı<br>Klemens            | 1.000 Adet       |              |
|   | BSK03            | 3'lü<br>Basmalı<br>Klemens            | 1.000 Adet       |              |



# KABLO BAĞLARI



2,5 x 150 mm



2,5 x 200 mm



3,6 x 250 mm





| Ürün Kodu | Kutu Adet | Ölçü         | Fiyat |
|-----------|-----------|--------------|-------|
| 14 1822 1 | 100 Adet  | 2,5 x 150 mm |       |



| Ürün Kodu | Kutu Adet | Ölçü         | Fiyat |
|-----------|-----------|--------------|-------|
| 14 1846 1 | 100 Adet  | 2,5 x 200 mm |       |



| Ürün Kodu | Kutu Adet | Ölçü         | Fiyat |
|-----------|-----------|--------------|-------|
| 14 3574 1 | 100 Adet  | 3,6 x 250 mm |       |

# KABLO KELEPÇESİ

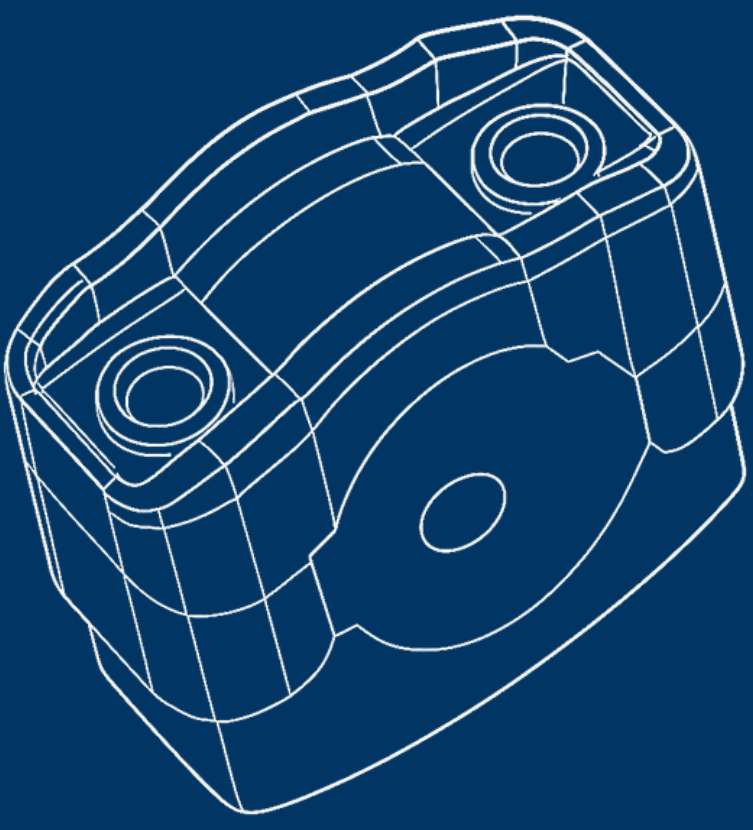



| Ürün Kodu | Kutu Adet | Ölçü     | Fiyat |
|-----------|-----------|----------|-------|
| TYPE-301  | 100 Adet  | 30-42 mm |       |



| Ürün Kodu | Kutu Adet | Ölçü     | Fiyat |
|-----------|-----------|----------|-------|
| TYPE-302  | 100 Adet  | 36-50 mm |       |



| Ürün Kodu | Kutu Adet | Ölçü     | Fiyat |
|-----------|-----------|----------|-------|
| TYPE-303  | 50 Adet   | 52-72 mm |       |

# MENHOLLER

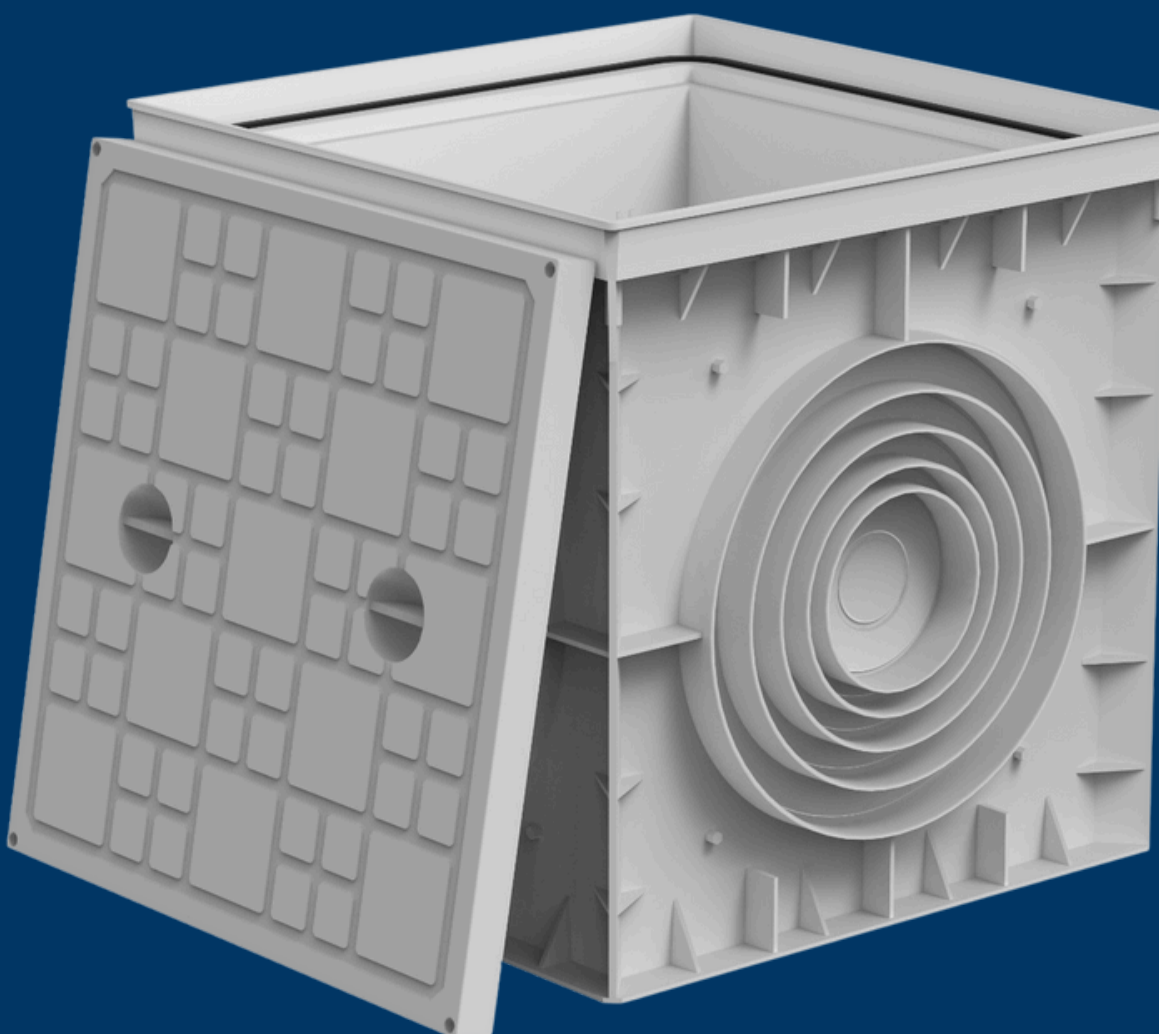
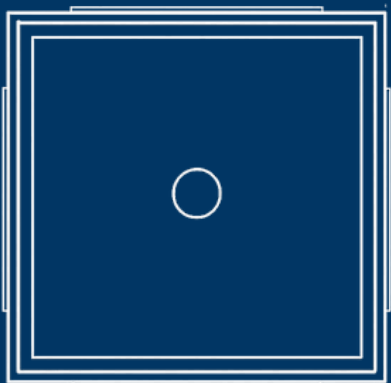

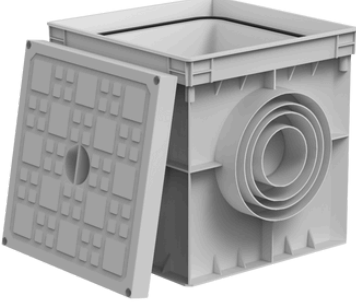

| Ürün Kodu | Ürün               | Ölçü (cm) | Fiyat |
|-----------|--------------------|-----------|-------|
| AK-20     | Menhol Düz Kapaklı | 20*20*20  |       |

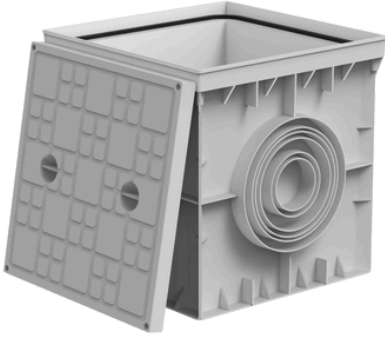

| Ürün Kodu | Ürün                           | Ölçü (cm) | Fiyat |
|-----------|--------------------------------|-----------|-------|
| AK-304    | Menhol Düz Kapaklı (4 Çıkışlı) | 30*30*30  |       |
| AK-306    | Menhol Düz Kapaklı (6 Çıkışlı) | 30*30*30  |       |

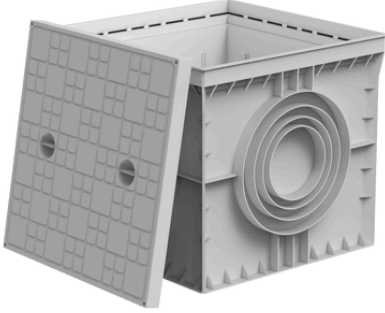

| Ürün Kodu | Ürün                           | Ölçü (cm) | Fiyat |
|-----------|--------------------------------|-----------|-------|
| AK-404    | Menhol Düz Kapaklı (4 Çıkışlı) | 40*40*40  |       |
| AK-406    | Menhol Düz Kapaklı (6 Çıkışlı) | 40*40*40  |       |

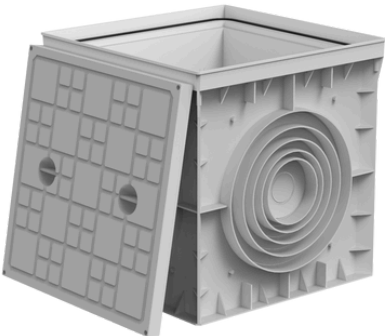

| Ürün Kodu | Ürün                           | Ölçü (cm) | Fiyat |
|-----------|--------------------------------|-----------|-------|
| AK-554    | Menhol Düz Kapaklı (4 Çıkışlı) | 55*55*50  |       |
| AK-556    | Menhol Düz Kapaklı (6 Çıkışlı) | 55*55*50  |       |

# RAKORRLAR

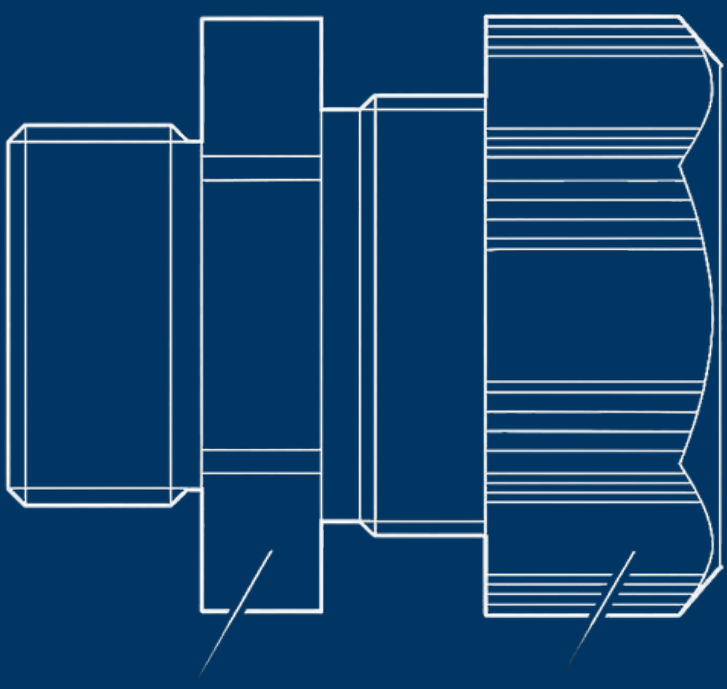

|    | <table border="1"><thead><tr><th>Gri Kodu</th><th>Siyah Kodu</th><th>Montaj Çapı (mm)</th><th>Kutu İçi Adet</th><th>Fiyat</th></tr></thead><tbody><tr><td>PG-7G</td><td>PG-7S</td><td>7</td><td>450 Adet</td><td></td></tr></tbody></table>       | Gri Kodu         | Siyah Kodu    | Montaj Çapı (mm) | Kutu İçi Adet | Fiyat | PG-7G    | PG-7S   | 7  | 450 Adet |  |
|---|---|------------------|---------------|------------------|---------------|-------|----------|---------|----|----------|--|
| Gri Kodu  | Siyah Kodu  | Montaj Çapı (mm) | Kutu İçi Adet | Fiyat            |               |       |          |         |    |          |  |
| PG-7G   | PG-7S   | 7                | 450 Adet      |                  |               |       |          |         |    |          |  |
|    | <table border="1"><thead><tr><th>Gri Kodu</th><th>Siyah Kodu</th><th>Montaj Çapı (mm)</th><th>Kutu İçi Adet</th><th>Fiyat</th></tr></thead><tbody><tr><td>PG-9G</td><td>PG-9S</td><td>8</td><td>300 Adet</td><td></td></tr></tbody></table>       | Gri Kodu         | Siyah Kodu    | Montaj Çapı (mm) | Kutu İçi Adet | Fiyat | PG-9G    | PG-9S   | 8  | 300 Adet |  |
| Gri Kodu  | Siyah Kodu  | Montaj Çapı (mm) | Kutu İçi Adet | Fiyat            |               |       |          |         |    |          |  |
| PG-9G   | PG-9S   | 8                | 300 Adet      |                  |               |       |          |         |    |          |  |
|   | <table border="1"><thead><tr><th>Gri Kodu</th><th>Siyah Kodu</th><th>Montaj Çapı (mm)</th><th>Kutu İçi Adet</th><th>Fiyat</th></tr></thead><tbody><tr><td>PG-11G</td><td>PG-11S</td><td>10</td><td>200 Adet</td><td></td></tr></tbody></table>    | Gri Kodu         | Siyah Kodu    | Montaj Çapı (mm) | Kutu İçi Adet | Fiyat | PG-11G   | PG-11S  | 10 | 200 Adet |  |
| Gri Kodu  | Siyah Kodu  | Montaj Çapı (mm) | Kutu İçi Adet | Fiyat            |               |       |          |         |    |          |  |
| PG-11G  | PG-11S  | 10               | 200 Adet      |                  |               |       |          |         |    |          |  |
|  | <table border="1"><thead><tr><th>Gri Kodu</th><th>Siyah Kodu</th><th>Montaj Çapı (mm)</th><th>Kutu İçi Adet</th><th>Fiyat</th></tr></thead><tbody><tr><td>PG-13,5G</td><td>PG-1,5S</td><td>12</td><td>175 Adet</td><td></td></tr></tbody></table> | Gri Kodu         | Siyah Kodu    | Montaj Çapı (mm) | Kutu İçi Adet | Fiyat | PG-13,5G | PG-1,5S | 12 | 175 Adet |  |
| Gri Kodu  | Siyah Kodu  | Montaj Çapı (mm) | Kutu İçi Adet | Fiyat            |               |       |          |         |    |          |  |
| PG-13,5G  | PG-1,5S   | 12               | 175 Adet      |                  |               |       |          |         |    |          |  |
|  | <table border="1"><thead><tr><th>Gri Kodu</th><th>Siyah Kodu</th><th>Montaj Çapı (mm)</th><th>Kutu İçi Adet</th><th>Fiyat</th></tr></thead><tbody><tr><td>PG-16G</td><td>PG-16S</td><td>14</td><td>125 Adet</td><td></td></tr></tbody></table>    | Gri Kodu         | Siyah Kodu    | Montaj Çapı (mm) | Kutu İçi Adet | Fiyat | PG-16G   | PG-16S  | 14 | 125 Adet |  |
| Gri Kodu  | Siyah Kodu  | Montaj Çapı (mm) | Kutu İçi Adet | Fiyat            |               |       |          |         |    |          |  |
| PG-16G  | PG-16S  | 14               | 125 Adet      |                  |               |       |          |         |    |          |  |



|    | <table border="1"><thead><tr><th>Gri Kodu</th><th>Siyah Kodu</th><th>Montaj Çapı (mm)</th><th>Kutu İçi Adet</th><th>Fiyat</th></tr></thead><tbody><tr><td>PG-21G</td><td>PG-21S</td><td>18</td><td>75 Adet</td><td></td></tr></tbody></table> | Gri Kodu         | Siyah Kodu    | Montaj Çapı (mm) | Kutu İçi Adet | Fiyat | PG-21G | PG-21S | 18 | 75 Adet |  |
|---|---|------------------|---------------|------------------|---------------|-------|--------|--------|----|---------|--|
| Gri Kodu  | Siyah Kodu  | Montaj Çapı (mm) | Kutu İçi Adet | Fiyat            |               |       |        |        |    |         |  |
| PG-21G  | PG-21S  | 18               | 75 Adet       |                  |               |       |        |        |    |         |  |
|    | <table border="1"><thead><tr><th>Gri Kodu</th><th>Siyah Kodu</th><th>Montaj Çapı (mm)</th><th>Kutu İçi Adet</th><th>Fiyat</th></tr></thead><tbody><tr><td>PG-29G</td><td>PG-29S</td><td>25</td><td>40 Adet</td><td></td></tr></tbody></table> | Gri Kodu         | Siyah Kodu    | Montaj Çapı (mm) | Kutu İçi Adet | Fiyat | PG-29G | PG-29S | 25 | 40 Adet |  |
| Gri Kodu  | Siyah Kodu  | Montaj Çapı (mm) | Kutu İçi Adet | Fiyat            |               |       |        |        |    |         |  |
| PG-29G  | PG-29S  | 25               | 40 Adet       |                  |               |       |        |        |    |         |  |
|   | <table border="1"><thead><tr><th>Gri Kodu</th><th>Siyah Kodu</th><th>Montaj Çapı (mm)</th><th>Kutu İçi Adet</th><th>Fiyat</th></tr></thead><tbody><tr><td>PG-36G</td><td>PG-36S</td><td>32</td><td>20 Adet</td><td></td></tr></tbody></table> | Gri Kodu         | Siyah Kodu    | Montaj Çapı (mm) | Kutu İçi Adet | Fiyat | PG-36G | PG-36S | 32 | 20 Adet |  |
| Gri Kodu  | Siyah Kodu  | Montaj Çapı (mm) | Kutu İçi Adet | Fiyat            |               |       |        |        |    |         |  |
| PG-36G  | PG-36S  | 32               | 20 Adet       |                  |               |       |        |        |    |         |  |
|  | <table border="1"><thead><tr><th>Gri Kodu</th><th>Siyah Kodu</th><th>Montaj Çapı (mm)</th><th>Kutu İçi Adet</th><th>Fiyat</th></tr></thead><tbody><tr><td>PG-42G</td><td>PG-42S</td><td>38</td><td>15 Adet</td><td></td></tr></tbody></table> | Gri Kodu         | Siyah Kodu    | Montaj Çapı (mm) | Kutu İçi Adet | Fiyat | PG-42G | PG-42S | 38 | 15 Adet |  |
| Gri Kodu  | Siyah Kodu  | Montaj Çapı (mm) | Kutu İçi Adet | Fiyat            |               |       |        |        |    |         |  |
| PG-42G  | PG-42S  | 38               | 15 Adet       |                  |               |       |        |        |    |         |  |
|  | <table border="1"><thead><tr><th>Gri Kodu</th><th>Siyah Kodu</th><th>Montaj Çapı (mm)</th><th>Kutu İçi Adet</th><th>Fiyat</th></tr></thead><tbody><tr><td>PG-48G</td><td>PG-48S</td><td>60</td><td>10 Adet</td><td></td></tr></tbody></table> | Gri Kodu         | Siyah Kodu    | Montaj Çapı (mm) | Kutu İçi Adet | Fiyat | PG-48G | PG-48S | 60 | 10 Adet |  |
| Gri Kodu  | Siyah Kodu  | Montaj Çapı (mm) | Kutu İçi Adet | Fiyat            |               |       |        |        |    |         |  |
| PG-48G  | PG-48S  | 60               | 10 Adet       |                  |               |       |        |        |    |         |  |

|    | <table><thead><tr><th>Gri Kodu</th><th>Siyah Kodu</th><th>Spiral Ölçü (mm)</th><th>Kutu İçi Adet</th><th>Fiyat</th></tr></thead><tbody><tr><td>AD10PG7 G</td><td>AD10PG7 S</td><td>6,5 x 10</td><td>150 Adet</td><td></td></tr></tbody></table>               | Gri Kodu         | Siyah Kodu    | Spiral Ölçü (mm) | Kutu İçi Adet | Fiyat | AD10PG7 G       | AD10PG7 S       | 6,5 x 10    | 150 Adet |  |
|--|---|------------------|---------------|------------------|---------------|-------|-----------------|-----------------|-------------|----------|--|
| Gri Kodu   | Siyah Kodu  | Spiral Ölçü (mm) | Kutu İçi Adet | Fiyat            |               |       |                 |                 |             |          |  |
| AD10PG7 G  | AD10PG7 S   | 6,5 x 10         | 150 Adet      |                  |               |       |                 |                 |             |          |  |
|    | <table><thead><tr><th>Gri Kodu</th><th>Siyah Kodu</th><th>Spiral Ölçü (mm)</th><th>Kutu İçi Adet</th><th>Fiyat</th></tr></thead><tbody><tr><td>AD13-PG9 G</td><td>AD13-PG9 S</td><td>10 x 13</td><td>100 Adet</td><td></td></tr></tbody></table>              | Gri Kodu         | Siyah Kodu    | Spiral Ölçü (mm) | Kutu İçi Adet | Fiyat | AD13-PG9 G      | AD13-PG9 S      | 10 x 13     | 100 Adet |  |
| Gri Kodu   | Siyah Kodu  | Spiral Ölçü (mm) | Kutu İçi Adet | Fiyat            |               |       |                 |                 |             |          |  |
| AD13-PG9 G   | AD13-PG9 S  | 10 x 13          | 100 Adet      |                  |               |       |                 |                 |             |          |  |
|   | <table><thead><tr><th>Gri Kodu</th><th>Siyah Kodu</th><th>Spiral Ölçü (mm)</th><th>Kutu İçi Adet</th><th>Fiyat</th></tr></thead><tbody><tr><td>AD15,58-PG11 G</td><td>AD15,58-PG11 S</td><td>12 x 15,8</td><td>70 Adet</td><td></td></tr></tbody></table>     | Gri Kodu         | Siyah Kodu    | Spiral Ölçü (mm) | Kutu İçi Adet | Fiyat | AD15,58-PG11 G  | AD15,58-PG11 S  | 12 x 15,8   | 70 Adet  |  |
| Gri Kodu   | Siyah Kodu  | Spiral Ölçü (mm) | Kutu İçi Adet | Fiyat            |               |       |                 |                 |             |          |  |
| AD15,58-PG11 G   | AD15,58-PG11 S  | 12 x 15,8        | 70 Adet       |                  |               |       |                 |                 |             |          |  |
|  | <table><thead><tr><th>Gri Kodu</th><th>Siyah Kodu</th><th>Spiral Ölçü (mm)</th><th>Kutu İçi Adet</th><th>Fiyat</th></tr></thead><tbody><tr><td>AD18,5-PG13,5 G</td><td>AD18,5-PG13,5 S</td><td>14,2 x 18,4</td><td>50 Adet</td><td></td></tr></tbody></table> | Gri Kodu         | Siyah Kodu    | Spiral Ölçü (mm) | Kutu İçi Adet | Fiyat | AD18,5-PG13,5 G | AD18,5-PG13,5 S | 14,2 x 18,4 | 50 Adet  |  |
| Gri Kodu   | Siyah Kodu  | Spiral Ölçü (mm) | Kutu İçi Adet | Fiyat            |               |       |                 |                 |             |          |  |
| AD18,5-PG13,5 G  | AD18,5-PG13,5 S   | 14,2 x 18,4      | 50 Adet       |                  |               |       |                 |                 |             |          |  |
|  | <table><thead><tr><th>Gri Kodu</th><th>Siyah Kodu</th><th>Spiral Ölçü (mm)</th><th>Kutu İçi Adet</th><th>Fiyat</th></tr></thead><tbody><tr><td>AD21,2-PG16 G</td><td>AD21,2-PG16 S</td><td>16,5 x 21,2</td><td>40 Adet</td><td></td></tr></tbody></table>     | Gri Kodu         | Siyah Kodu    | Spiral Ölçü (mm) | Kutu İçi Adet | Fiyat | AD21,2-PG16 G   | AD21,2-PG16 S   | 16,5 x 21,2 | 40 Adet  |  |
| Gri Kodu   | Siyah Kodu  | Spiral Ölçü (mm) | Kutu İçi Adet | Fiyat            |               |       |                 |                 |             |          |  |
| AD21,2-PG16 G  | AD21,2-PG16 S   | 16,5 x 21,2      | 40 Adet       |                  |               |       |                 |                 |             |          |  |





| Gri Kodu      | Siyah Kodu    | Spiral Ölçü (mm) | Kutu İçi Adet | Fiyat |
|---------------|---------------|------------------|---------------|-------|
| AD28,5-PG21 G | AD28,5-PG21 S | 23,5 x 28,4      | 20 Adet       |       |



| Gri Kodu      | Siyah Kodu    | Spiral Ölçü (mm) | Kutu İçi Adet | Fiyat |
|---------------|---------------|------------------|---------------|-------|
| AD34,5-PG29 G | AD34,5-PG29 S | 29 x 34,5        | 15 Adet       |       |



| Gri Kodu      | Siyah Kodu    | Spiral Ölçü (mm) | Kutu İçi Adet | Fiyat |
|---------------|---------------|------------------|---------------|-------|
| AD42,5-PG36 G | AD42,5-PG36 S | 36 x 42,5        | 12 Adet       |       |



| Gri Kodu      | Siyah Kodu    | Spiral Ölçü (mm) | Kutu İçi Adet | Fiyat |
|---------------|---------------|------------------|---------------|-------|
| AD54,5-PG48 G | AD54,5-PG48 S | 48 x 54,5        | 8 Adet        |       |



# PROJE CEPLELERİ

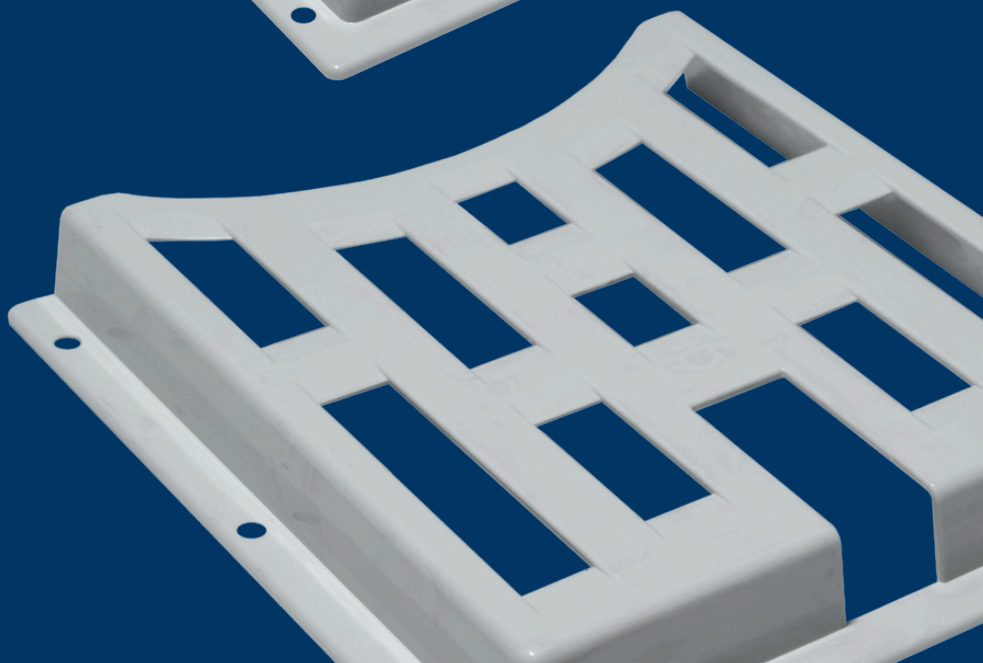
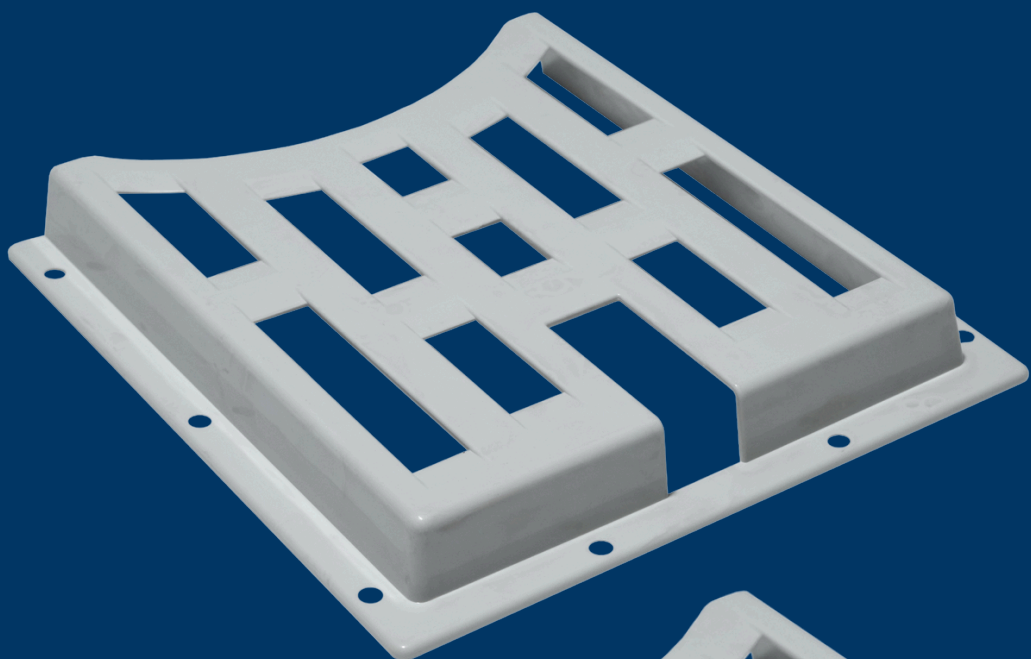
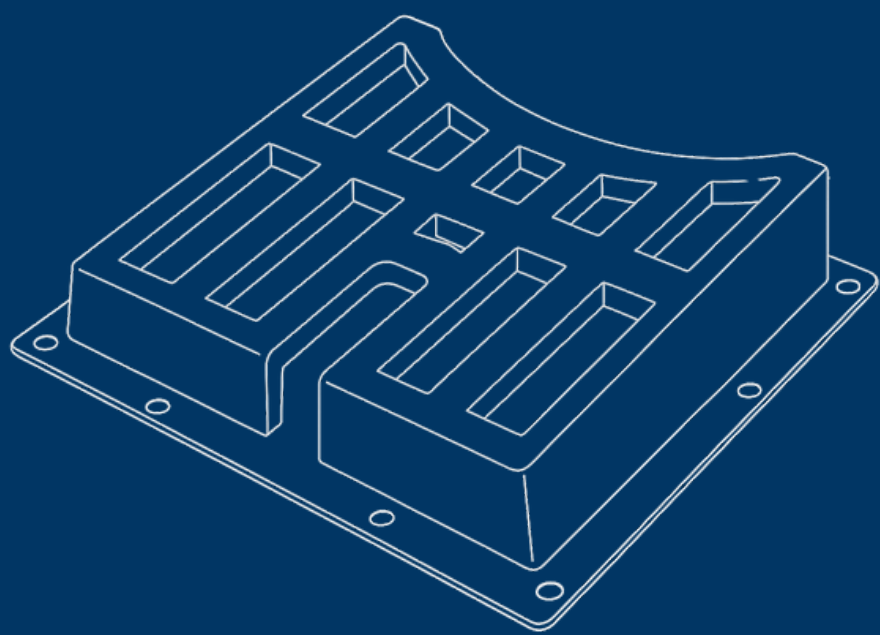

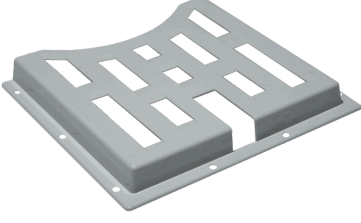

| Ürün Kodu | Ürün             | Kutu Adet | Hammadde | Fiyat |
|-----------|------------------|-----------|----------|-------|
| 1824-S    | A4 Proje Cepleri | 25 Adet   | Abs      |       |

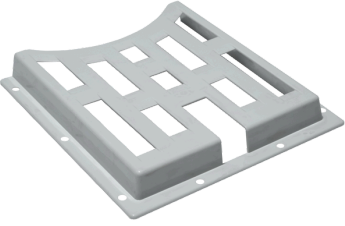

| Ürün Kodu | Ürün             | Kutu Adet | Hammadde | Fiyat |
|-----------|------------------|-----------|----------|-------|
| 1824-L    | A5 Proje Cepleri | 25 Adet   | Abs      |       |

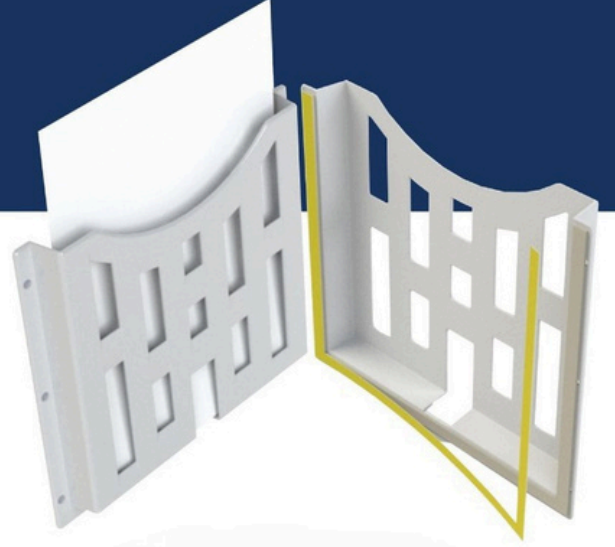

# İLETİŞİM



(0212) 671 39 79



+90 530 260 20 01



[www.akiskalip.com](http://www.akiskalip.com)



[info@akiskalip.com](mailto:info@akiskalip.com)



Eski Turgut Özal Cad. Altıntaç İş Merkezi  
D.Blok No: 406 - 403 Başakşehir / İSTANBUL





# SEBOX®

“Üretimde Kalite, Kalıpta Uzmanlık”



AK-İŞ KALIP®